

PAT WILSON'S

PARTS '58-'66

# Thunderbird

NEW • USED • REPRO • REBUILT



**We Buy, Sell, Trade Parts, Trade Cars, and Part Out Many Cars**

Information: (973) 579-7205

Orders Only: (888) 262-1153

24-Hour Fax: (973) 579-2011

375 Rt. 94 Fredon Twp, NJ 07860

Email: [info@wilsonbird.com](mailto:info@wilsonbird.com)

Web: [www.wilsonbird.com](http://www.wilsonbird.com)

**MANY NEW ITEMS! We Have The Little Stuff, Too**

HOURS: M-F 9:00 am - 8:00 pm EST

SAT 9:00 am - 4:00 pm EST



2016 CATALOG

## Interior Parts



**58-59 VINYL**



**58-59 LEATHER**

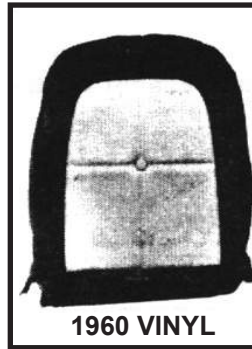

**1960 VINYL**

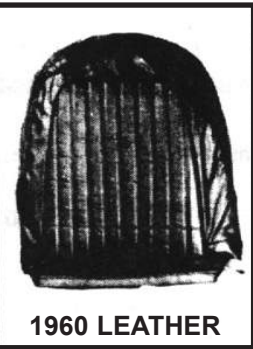

**1960 LEATHER**

### Leather and Vinyl Upholstery

Our seat covers are made from premium vinyls and leathers, and are stitched with the correct welting (piping) to make them as genuine as possible. They are available in all factory colors as follows:

- 1958** - Black & White, Red & White, Blue & White, Gulfstream & White, Green & White, Palomino & White. All 1958 upholstery is made silver tinsel welt as original.
- 1959** - Black & White, Red & White, Dark Blue & Light Blue, Turquoise & White, Green & White, Hickory (Tan) & White. All 1959 upholstery is made with silver tinsel welt as original.
- 1960** - Black & White, Red & White, Dark Blue & Light Blue, Dark Turquoise & Light Turquoise, Dark Green & Light Green, Dark Beige & Light Beige. All 1960 upholstery is made with trim colored welt as original.
- 1961** - Black, Red, Light Blue, Metallic Turquoise, Metallic Light Beige, Pearl White. All 1961 upholstery is made with trim colored welt as original.
- 1962** - Black, Red, Light Blue Metallic, Silver Blue Metallic, Turquoise Metallic, Light Beige (Pearl White), Medium Chestnut Metallic (Rust). All 1962 upholstery is made with trim colored welt as original.
- 1963** - Black w/ Black Vachette inserts, Red w/ Red Vachette inserts, Medium Blue w/ Light Blue Vachette inserts, Medium Turquoise w/ Light Turquoise Vachette inserts, Light Beige (Pearl White) w/ Light Beige Vachette inserts, Light Rose Beige w/ Light Rose Beige Vachette inserts, Light Gold (Silver Gold) w/ Light Gold Vachette inserts, Medium Chestnut (Rust) w/ Medium Chestnut vachette inserts. All 1963 upholstery is made with silver tinsel welt as original.
- 1964** - Black, Red, Light Blue, Light Silver Blue, Light Turquoise, White, Medium Palomino, Light Rose Beige, Light Beige (Silver Gold), Light Aztec Gold. All 1964 upholstery is made with trim colored welt as original.
- 1965** - Black, Red, Burgundy, Dark Blue, Light Silver Mink (Silver Blue), Light Aqua, White, Light Ivy Gold (Green), Parchment, Medium Emberglow (Rust), Pearl White. All 1965 upholstery is made with trim colored welt as original.
- 1966** - Black, Red, Burgundy, Dark Blue, Light Silver Mink (Silver Blue), Light Aqua, White, Light Ivy Gold (Green), Parchment, Medium Emberglow (Rust), Pearl White. All 1966 upholstery is made with trim colored welt as original.

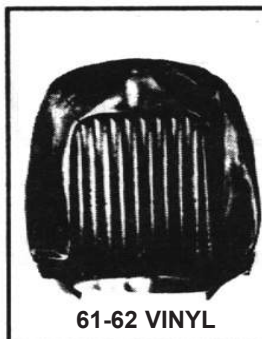

**61-62 VINYL**

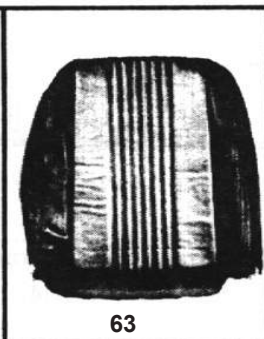

**63**

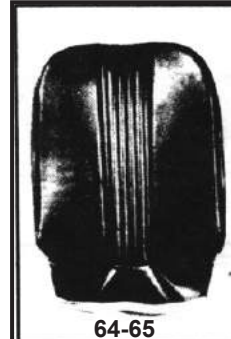

**64-65**

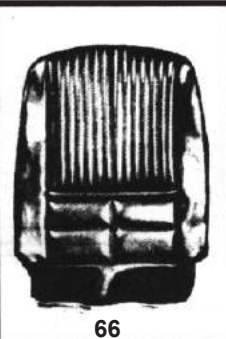

**66**

	<u>Vinyl</u>	<u>Leather</u>
1958-1966 Fronts Only	\$300.00	\$ 950.00
1958-1966 Complete Set, F and R	\$500.00	\$1450.00
1963 Add:	\$ 10.00	\$ 25.00
1964-1966 w/ Pass. Recliner add:	\$ 55.00	\$ 150.00

**For monthly specials, please visit our website: [www.wilsontbird.com](http://www.wilsontbird.com)**



# Interior Parts

## Seat Foams & Hardware

- A. 1958-1966 Front Seat Foams, per Seat \$145.00
- 1958-1960 Rear Seat Foams, Set \$350.00
- B. 1961-1962 Rear Seat Foams, Set \$350.00
- C. 1961-1962 Rear Seat Emblem, new \$ 35.00
- 1963 Rear Seat Foams, Set \$350.00
- D. 1964-1966 Seat Emblems, new, each \$ 29.95
- 1964-1966 Rear Seat Foams, Set \$350.00
- E. Pliers and Hog Rings, Set \$ 23.00

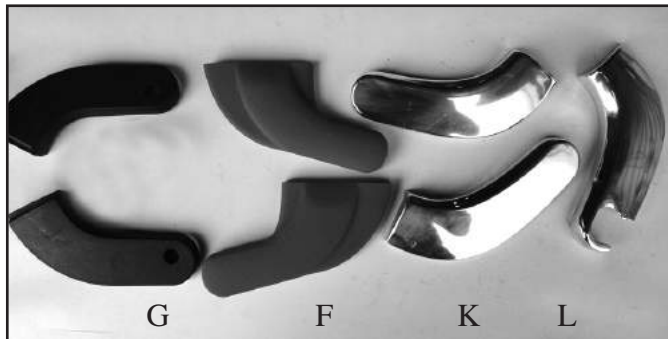
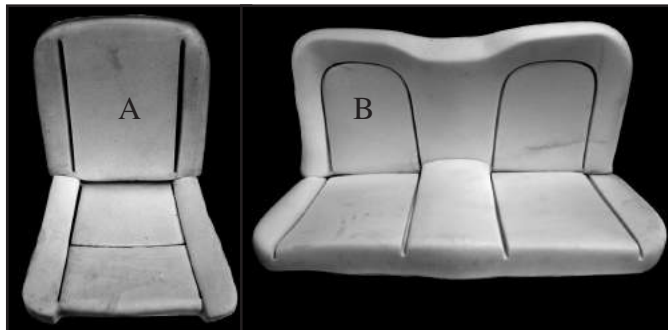

## Seat Skirts & Related Parts

- 1958-1960 Seat Skirts, used CALL
- F. 1958-1960 Seat Hinge Covers, pair, does \$ 30.00
- one seat, Black or Red
- G. 1961-1962 Seat Hinge Covers, per seat: Black, \$ 30.00
- Red, Bone, Brown, Blue, Turquoise, Chestnut, or Silver Blue
- 1963 Outer Seat Hinge Covers, used \$ 30.00
- H. 1961-1963 Seat Hinge Pin Covers, 2 piece set \$ 28.00
- J. 1961-1963 Seat Skirts, pair, formed in \$ 89.95
- Black ABS plastic like original.
- K. 1964-1966 Seat Hinge Covers, used \$ 25.00
- L. 1965-1966 Recliner Seat Hinge Covers, used \$ 25.00
- 1965-1966 Recliner Seat Handle, new \$ 49.95
- 1964-1966 Seat Skirts, used, each \$ 25.00

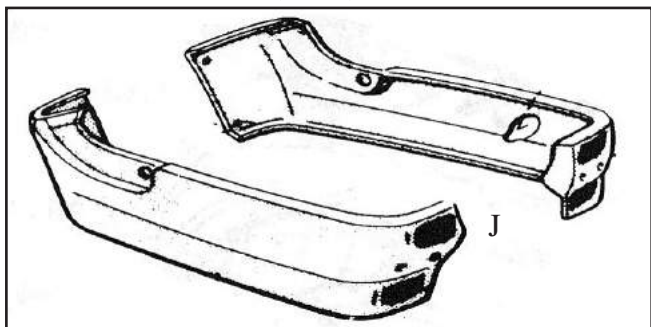
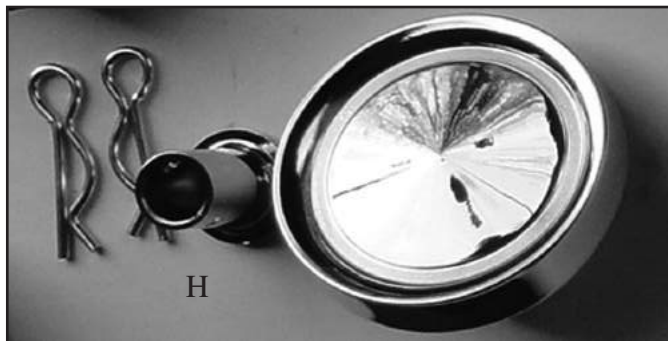

## Interior & Vinyl Dye

These dyes are specially matched to all original Thunderbird interior colors. You can be sure that they will be a match to your interior, and this dye is specially formulated to resist cracking or chipping. It can be used on all vinyl surfaces of the interior for that factory fresh look! Please have trim code available when ordering.

- Interior Vinyl Dye, per can \$ 19.95
- Vinyl Surface Prep and Cleaner, per can \$ 19.95
- Interior Vinyl Clear Coat, per can \$ 19.95

## Seat Belts

- 1958-1966 Standard Replacement, 62", Front or Rear \$29.00
- 1958-1963 Sister Hook, 62", Like Original \$35.00
- 1958-1966 Standard Replacement, 74", Front or Rear \$35.00
- 1958-1963 Sister Hook, 74", Like Original \$52.00
- 1964-1965 Original Seatbelts, used CALL
- 1966 Original Seatbelts, used CALL



# Interior Parts

## Door Panels

Our door panels are made from high density molded plastic and covered with premium vinyl material to insure protection against moisture, warping, and breakage, especially in the armrest area.

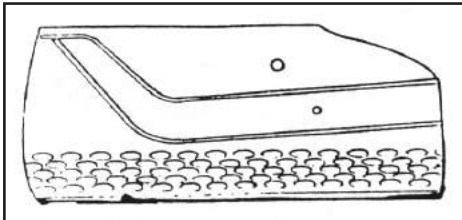

**A. 1958-1959**

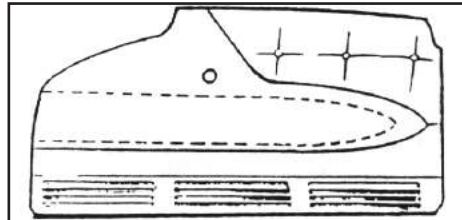

**B. 1960**

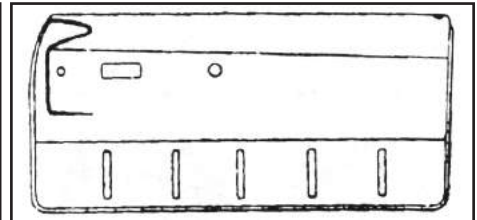

**C. 1961 - Early 1962**

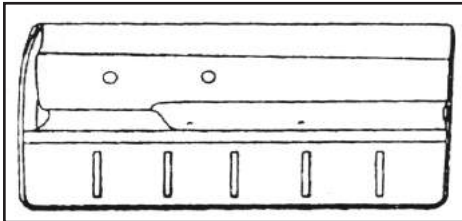

**D. Late 1962-1963**

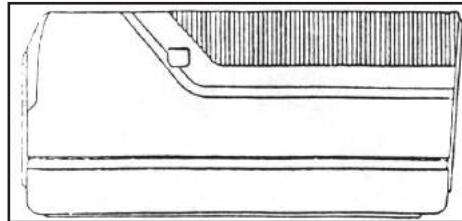

**E. 1964 - 1965**

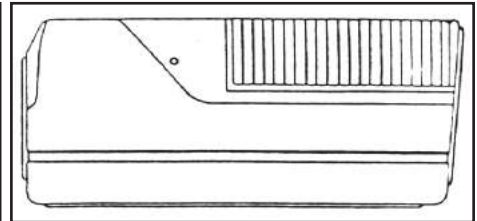

**F. 1966**

- |  |          |
|--|----------|
| A. 1958-1959 Door Panels, All Original Colors, with Correct Lower Embossing, pair                  | \$575.00 |
| B. 1960 Door Panels, All Original Colors, with Correct Lower Embossing, pair                       | \$575.00 |
| C. 1961-Early 1962 Door Panels, Black or White, Armrest Not Included, pair                         | \$575.00 |
| D. Late 1962-1963 Door Panels, Black or White, with Molded Armrest, pair                           | \$575.00 |
| 1962-1963 Combo Door Panels, Black or White, pair  | \$575.00 |
| (These have the Early Style Dash cutouts in Front, but with the Molded Armrest of the Later Style) |          |
| E. 1964-1965 Door Panels, Black or White, pair   | \$575.00 |
| F. 1966 Door Panels, Black or White, pair  | \$575.00 |

## Door Panel Parts

- |   |          |
|---|----------|
| G. 1958-1959 Door Panel Cups, pair  | \$ 20.00 |
| H. 1958-1960 Door Panel Lower Edge Retainers, new, pair                                       | \$ 40.00 |
| J. 1961-1963 Door Panel Side Edge Retainers, Chrome, 4 piece set                              | \$ 79.95 |
| 1961-1963 Door Panel Lower Edge Retainers, new, pair  | \$ 40.00 |
| G. Late 1962-1963 Door Panel Cups, pair   | \$ 20.00 |
| K. 1964-1966 Door Panel Side Edge Retainers, Chrome, 8 piece set                              | \$ 50.00 |
| L. 1965 Door Panel Cup, used, with insert, each   | \$ 10.00 |
| M. 1966 Door Panel Cup, each: Black, Red, Maroon, Parchment or White (will also work on 1965) | \$ 10.95 |
| 1965-1966 Door Panel Cup Insert, each: Black, Red, Maroon, Parchment, or White                | \$ 3.95  |
| N. 1965-1966 Door Panel Cup Support Brackets, Left or Right, new, pair                        | \$ 15.00 |

## Door Panel Repairs

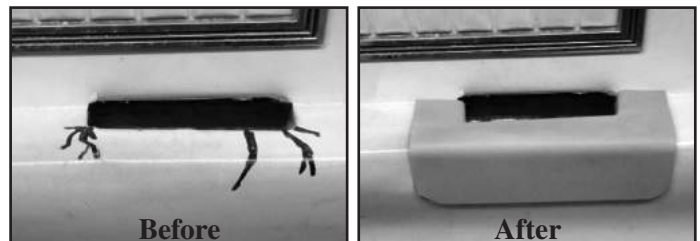
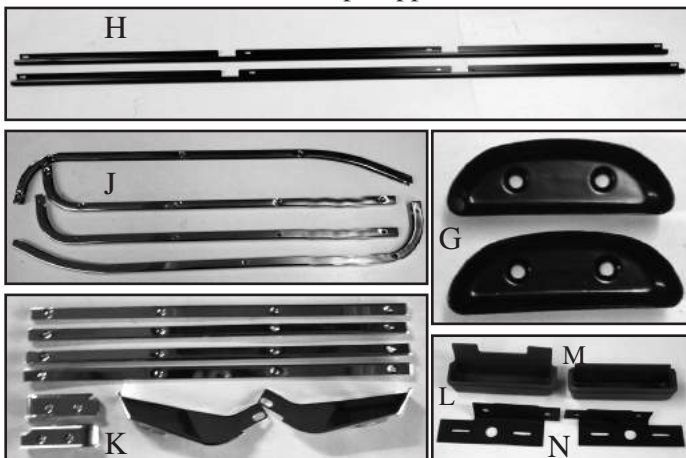

These repair pieces are an inexpensive way to repair the common cracking around the door pull area on 1965-1966 door panels. They are made of thin steel and come primed, ready to be painted to match your panels.

One Pair \$ 39.95

For monthly specials, please visit our website: [www.wilsontbird.com](http://www.wilsontbird.com)

# Interior Parts

## Dash Pads

- |                                  |          |
|----------------------------------|----------|
| A. 1958-1960 New, Black or White | \$425.00 |
| B. 1961-1963 New, Black or White | \$425.00 |
| 1964-1966 Used                   | CALL     |

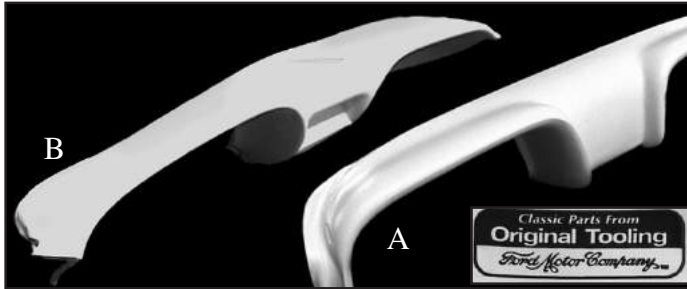

## Corrugated Aluminum Trim

- |  |          |
|--|----------|
| 1961-1963 Right Dash, Without AC         | \$125.00 |
| 1961-1963 Right Dash, With AC            | \$ 95.00 |
| 1961-1963 Left Dash                      | \$ 45.00 |
| 1961-1963 Center Dash, With AC           | \$ 50.00 |
| 1961-1962 Console Trim                   | \$ 75.00 |
| 1963 Console Trim, With Power Windows    | \$ 75.00 |
| 1963 Console Trim, Without Power Windows | \$ 75.00 |
| 1961-1963 Ash Tray Trim                  | \$ 25.00 |
| 1961-Early 1962 Door Panel Trim, L or R  | \$ 95.00 |
| Late 1962-1963 Door Panel Trim, L or R   | \$ 95.00 |
| 1961-1963 Rear Seat Quarter Trim, L or R | \$ 25.00 |



## Roadster Grab Bars

- |                               |          |
|-------------------------------|----------|
| C. Red, Black, or Pearl White | \$295.00 |
|-------------------------------|----------|

## Dash Scripts

- |                                     |          |
|-------------------------------------|----------|
| D. 1958-1960 Glove Box Script, used | \$ 25.00 |
| E. 1961-1963 Dash Script, new       | \$ 25.00 |
| F. 1964-1966 Dash Script, used      | \$ 25.00 |



## Door and Window Handles

- |  |         |
|--|---------|
| G. 1958-1963 Inside Door Handle                  | \$25.00 |
| H. 1958-1963 Door Handle Spring                  | \$ 1.50 |
| J. 1961-1963 Door Handle Escutcheon              | \$10.50 |
| K. 1958-1966 Door/Window Handle Clip             | \$ .50  |
| L. 1958-1966 Door/Window Clip Removal Tool       | \$ 6.95 |
| M. 1964-1966 Inside Door Handle, Left or Right   | \$25.00 |
| N. 1964-1966 Inside Door Handle Escutcheon, pr.  | \$14.95 |
| 1961-1963 Door Handle Pivot, L or R, new, ea.    | \$44.95 |
| P. 1964-1966 Door Handle Pivot, L or R, new, ea. | \$44.95 |
| 1961-1966 Door Handle Pivot, L or R, used, ea.   | \$20.00 |
| Q. 1958 Window Crank Handle                      | \$30.00 |
| R. 1958-1960 Window Handle Escutcheon, used      | \$ 7.00 |
| S. 1959-1960 Window Crank Handle                 | \$30.00 |
| T. 1961-1963 Window Crank Handle                 | \$30.00 |
| U. 1961-1963 Window Handle Escutcheon            | \$10.50 |
| V. 1961-1966 Window Handle Escutcheon            | \$ 2.50 |
| (white plastic)                                  |         |
| W. 1964-1966 Front Window Crank Handle           | \$16.00 |
| 1964-1966 Rear Window Crank Handle               | \$16.00 |
| X. 1964-1966 Vent Window Crank Handle, used      | \$25.00 |
| Y. 1964-1966 Rear Window Handle Escutcheon       | \$ 2.50 |
| (white plastic)                                  |         |

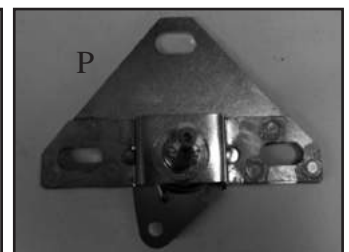
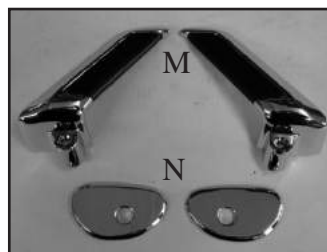



# Interior Parts

## Interior Combo Set

1958-1959 Complete Kit	\$710.00
1958-1959 Door Panels	\$575.00
1958-1959 Kick Panels	\$ 71.00
1958-1959 1/4 Trim Covers	\$ 50.00
1958-1959 Rear Arm Rest Covers	\$ 50.00

## Vinyl Interior Combo Set

1960 Complete Kit	\$800.00
1960 Door Panels	\$575.00
1960 Kick Panels	\$ 71.00
1960 1/4 Trim Panels	\$120.00
1960 Rear Arm Rest Covers	\$ 50.00

## Leather Interior Combo Set

1960 Complete Kit	\$800.00
1960 Door Panels	\$575.00
1960 Kick Panels	\$ 71.00
1960 1/4 Trim Panels	\$135.00
1960 Rear Arm Rest Covers	\$ 50.00

## Firewall Insulation

1958-1960 Die Cut Firewall Insulation	\$ 79.00
1961-1963 Die Cut Firewall Insulation	\$ 89.95
A. 1964-1966 Die Cut Firewall Insulation	\$ 99.95

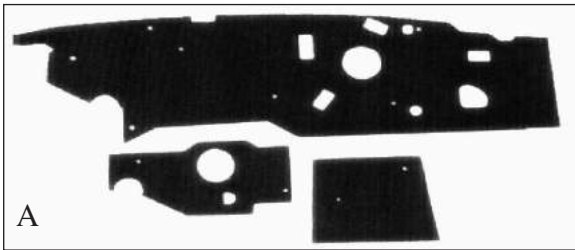

A

## Door Lock Knobs and Grommets

B. 1958-1960 Lock Knob	\$ 5.95
C. 1961-1963 Lock Knob	\$ 5.95
D. 1964 Lock Knob	\$ 5.95
E. 1965-1966 Lock Knob	\$ 3.95
F. 1958-1960 Lock Knob Grommet	\$ 3.95
G. 1961-1963 Lock Knob Grommet	\$ 3.95
H. 1964 Lock Knob Grommet	\$ 6.95
J. 1965-1966 Lock Knob Grommet	\$ 6.95

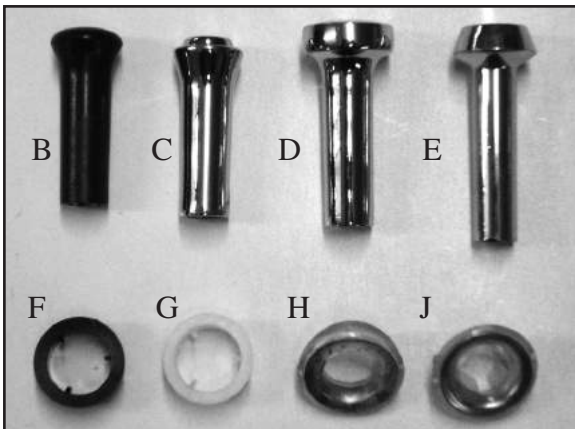

B

C

D

E

F

G

H

J

## Kick Panels

1961-1962 Pair	\$ 95.00
1963 Pair	\$100.00
1964-1966 Convertible, pair	\$ 95.00
1964-1966 Hard Top, pair	\$ 95.00
1963-1966 Used, each	\$ 25.00

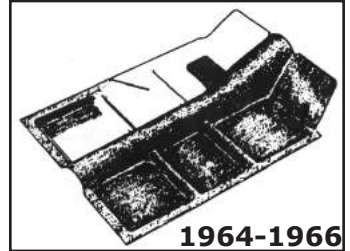

1964-1966

## Carpet Sets

Made of 80/20 rayon/nylon loop.

1958-1963 carpets are properly bound and stitched as original. 1964-1966 carpets are molded, and all have the correct heel toe pads with 1/2 inch jute backing. Available in all factory colors.

1958-1960 Carpet Set, 9 pieces	\$169.00
1961-1963 Carpet Set, 11 pieces	\$169.00
1964-1966 Carpet Set, 2 pieces	\$189.00
1964-1966 Door Panel Carpets, pair	\$ 50.00

## Quarter Trim Panels

1958-1959 Factory Design, pair	\$ 50.00
1960 Leather Design, pair	\$120.00
1960 Vinyl Design, pair	\$135.00
1961-1963 Convertible, used, each	CALL
1961-1963 Hard Top, used, each	CALL
1964-1966 Convertible, used, each	CALL
1964-1966 Hard Top, used, each	CALL
1966 Landau & Town HT, used, each	CALL



K

## Door Latch Assemblies

K. 1964 Right Side, new	\$ 65.00
1964 Left Side, new	\$ 65.00
1958-1966 Used, Left or Right	\$ 65.00

## Windlace

1958-1960 10 foot length, enough for one car.	\$ 33.00
Available in Black, Red, Dark Brown, Green, Tan, Dark Blue or Turquoise.	
1961-1966 8 foot length, enough for one car.	\$ 16.00
Available in Black or White.	

For monthly specials, please visit our website: [www.wilsonsbird.com](http://www.wilsonsbird.com)

# Dash Bezels

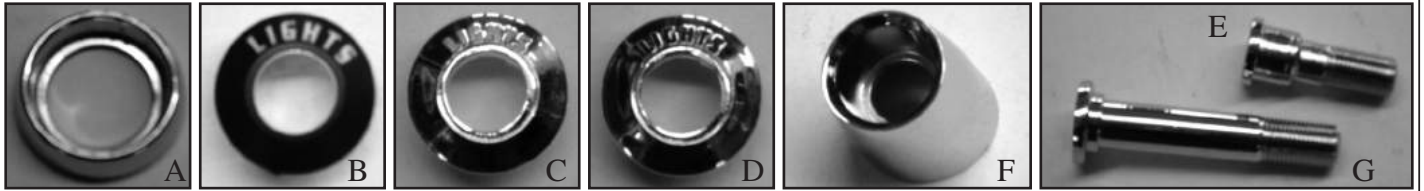

## Headlight Switch Bezels

- A. 1958-1960 Chrome Outer Bezel Ring \$14.00
- B. 1958-1959 Headlight Switch Inner Bezel, Black \$16.00
- C. 1960 Headlight Switch Inner Bezel, Clear Letters \$20.00
- D. 1960 Headlight Switch Inner Bezel, Green Letters \$20.00
- E. 1958-1960 Headlight Switch Bezel Nut \$15.00
- F. 1961-1963 Headlight Switch Bezel \$25.00
- G. 1961-1963 Headlight Switch Bezel Nut \$15.00

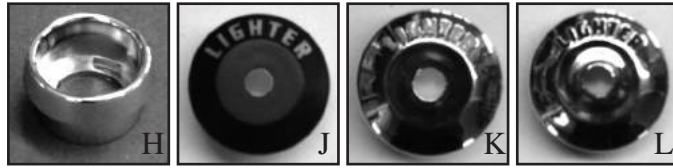

## Lighter Bezels

- H. 1958-1960 Chrome Outer Lighter Bezel \$20.00
- J. 1958-1959 Lighter Inner Bezel, Black \$16.00
- K. 1960 Lighter Inner Bezel, Clear Letters \$20.00
- L. 1960 Lighter Inner Bezel, Green Letters \$20.00



## Wiper Switch Bezels

- A. 1958-1960 Chrome Outer Bezel Ring \$14.00
- M. 1958-1959 Wiper Switch Inner Bezel, Black \$16.00
- N. 1960 Wiper Switch Inner Bezel, Clear Letters \$20.00
- P. 1960 Wiper Switch Inner Bezel, Green Letters \$20.00
- Q. 1958-1960 Wiper Switch Bezel Nut \$13.00
- R. 1961-1963 Wiper Switch Bezel \$25.00
- S. 1961-1963 Wiper Switch Bezel Nut \$15.00

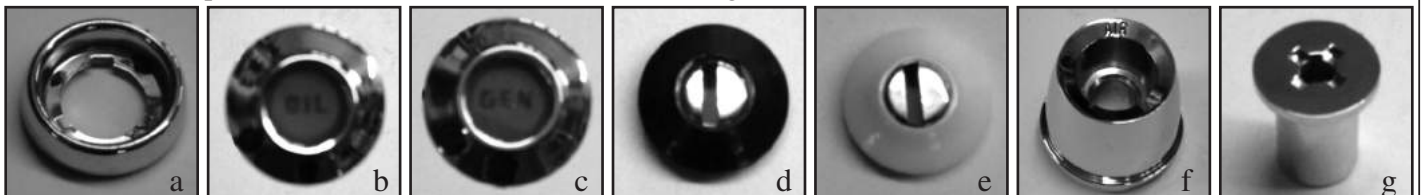

## Ignition Switch Bezels

- A. 1958-1960 Chrome Outer Bezel Ring \$14.00
- T. 1958-1959 Ignition Switch Bezel, Black \$19.00
- U. 1960 Ignition Switch Inner Bezel, Clear Letters \$20.00
- V. 1960 Ignition Switch Inner Bezel, Green Letters \$20.00
- W. 1958-1960 Ignition Switch Bezel Nut \$13.00
- X. 1961-1963 Ignition Switch Bezel \$30.00
- Y. 1964 Ignition Switch Bezel \$30.00
- Z. 1965-1966 Ignition Switch Bezel \$30.00

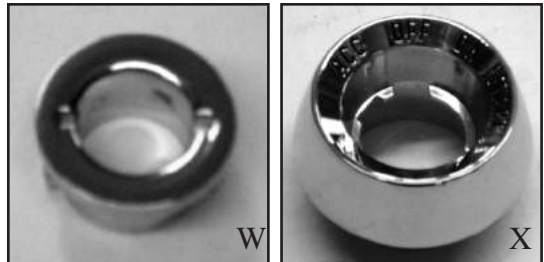

## Other Dash Bezels

- a. 1958-1960 Oil / Generator Light Outer Bezel \$14.00
- b. 1958-1960 Oil Warning Light Inner Bezel \$22.00
- c. 1958-1960 Generator Light Inner Bezel \$22.00
- d. 1958 Glove Box Lock Bezel, Black \$13.00
- e. 1959-1960 Glove Box Lock Bezel, White \$13.00
- f. 1961-1963 LH Vent Cable Bezel \$25.00
- g. 1961-1963 LH Vent Cable Bezel Nut \$15.00

# Dash Knobs

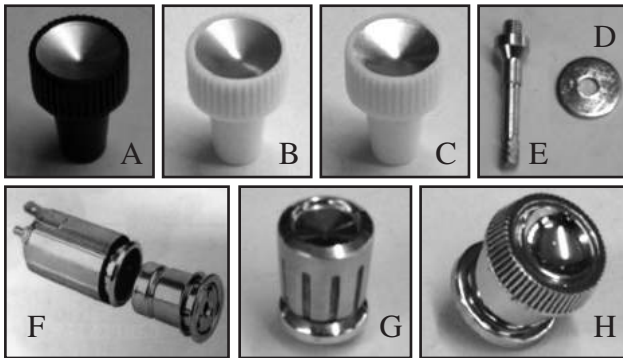

## Cigar Lighter Knobs

- |                                       |         |
|---------------------------------------|---------|
| A. 1958 Black with Silver Insert      | \$ 5.00 |
| B. 1959 White with Gold Insert        | \$ 6.00 |
| C. 1960 White with Silver Insert      | \$ 5.00 |
| D. 1958-1960 Chrome Washer            | \$ 2.50 |
| E. 1958-1960 Lighter Knob Stem        | \$ 5.00 |
| F. 1958-1966 Lighter Element and Well | \$19.00 |
| G. 1961-1963 Lighter Knob, used       | \$15.00 |
| H. 1964-1966 Lighter Knob, used       | \$15.00 |

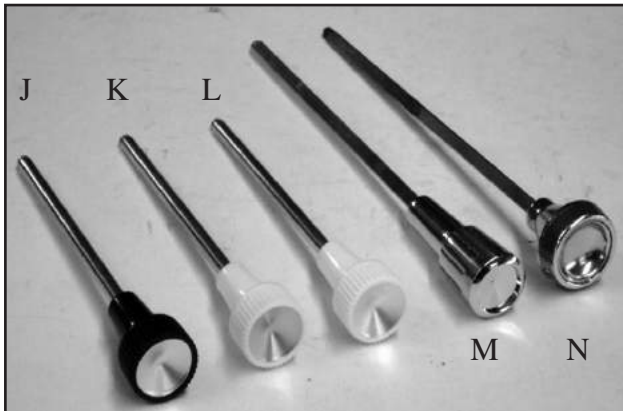

## Headlight Switch Knobs with Stem

- |                                  |         |
|----------------------------------|---------|
| J. 1958 Black with Silver Insert | \$10.00 |
| K. 1959 White with Gold Insert   | \$10.00 |
| L. 1960 White with Silver Insert | \$10.00 |
| M. 1961-1963 Knob and Stem       | \$20.00 |
| N. 1964 Knob and Stem, used      | \$15.00 |
| 1965-1966 Knob and Stem, used    | \$15.00 |

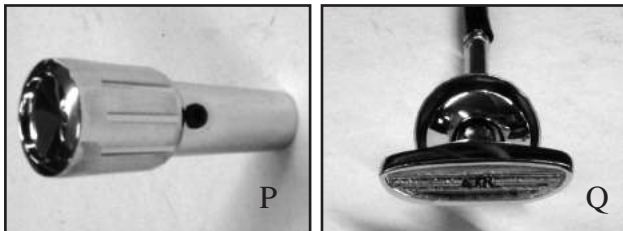

## Fresh Air Vent Knobs

- |   |         |
|---|---------|
| 1958-1960 Black, used, each             | CALL    |
| P. 1961-1963 LH Vent Knob, new          | \$19.95 |
| Q. 1961-1963 RH Vent Handle w/ Cable    | \$49.95 |
| 1964-1966 Vent Knob, Chrome, used, each | \$ 5.00 |

## Dash Knob and Bezel Kits

- |                                     |          |
|-------------------------------------|----------|
| 1958 Complete Set, 23 Pieces        | \$183.00 |
| 1959 Complete Set, 23 Pieces        | \$192.00 |
| 1960 Complete Set, Green, 24 Pieces | \$240.00 |
| 1960 Complete Set, Clear, 24 Pieces | \$240.00 |

## Radio Knobs

- |   |         |
|---|---------|
| R. 1958 Inner, Black with Silver Insert, 2 req., each | \$ 5.00 |
| S. 1959 Inner, White with Gold Insert, 2 req., each   | \$ 6.00 |
| T. 1960 Inner, White with Silver Insert, 2 req., each | \$ 5.00 |
| U. 1958-1960 Outer, Chrome, 2 req., each              | \$ 7.00 |
| V. 1961-1963 Inner or Outer, Chrome, used             | CALL    |
| W. 1964-1966 Inner or Outer, Chrome, used             | CALL    |

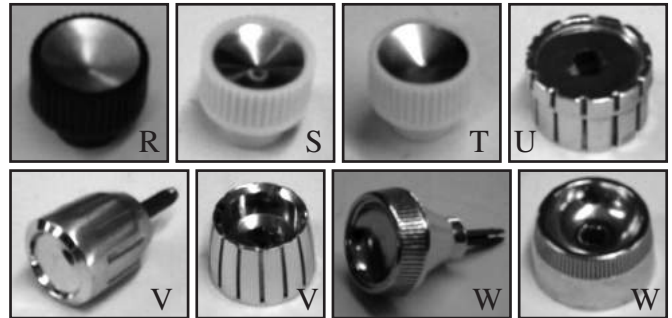

## Windshield Wiper Knobs

- |  |         |
|--|---------|
| X. 1958 Black with Silver Insert*                | \$10.00 |
| Y. 1959 White with Gold Insert*                  | \$10.00 |
| Z. 1960 White with Silver Insert*                | \$10.00 |
| *These knobs are also used for the two AC cables |         |
| P. 1961-1963 Chrome, new                         | \$20.00 |
| 1964-1966 Chrome, used                           | \$ 5.00 |

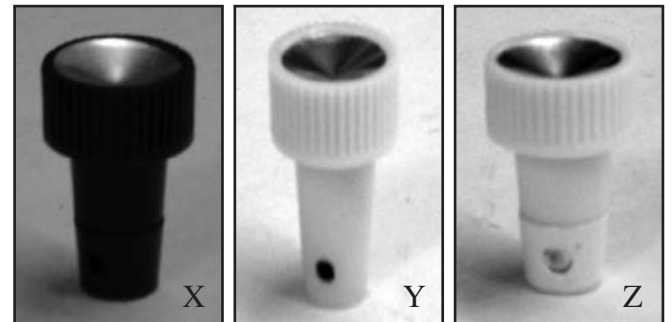

## Heater Control Knobs

- |                                      |         |
|--------------------------------------|---------|
| a. 1958 Black, 2 required, each      | \$ 5.00 |
| b. 1958 Fan Switch Knob, Black       | \$ 6.00 |
| c. 1959-1960 White, 2 required, each | \$ 5.00 |
| d. 1959-1960 Fan Switch Knob, White  | \$ 6.00 |
| 1961-1963 Chrome, used, each         | \$ 5.00 |
| 1964-1966 Chrome, used, each         | CALL    |

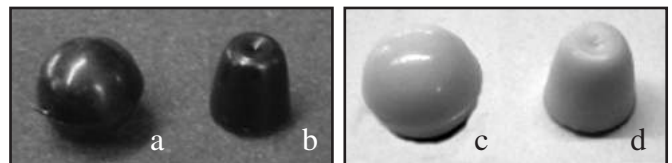

For monthly specials, please visit our website: [www.wilsonbird.com](http://www.wilsonbird.com)



# Interior Parts

## Trunk Mat Sets

Specify Hard Top or Convertible

1958-1966 Vinyl with Hardware	\$150.00
1958-1966 Standard Tire Cover	\$ 30.00
1964-1966 Deluxe Tire Cover	\$ 75.95

## Accelerator & Brake Pedals

A. 1958-1960 Accelerator Pedal	\$ 13.50
B. 1961-1962 Accelerator Pedal	\$ 15.50
C. 1963-1964 Accelerator Pedal	\$ 50.00
D. 1965-1966 Accelerator Pedal	\$ 50.00
E. 1958-1962 Brake Pedal Pad	\$ 12.00
F. 1963-1964 Brake Pedal	\$ 50.00
G. 1965-1966 Brake Pedal	\$ 50.00
H. 1961-1962 Parking Brake Pedal Pad	\$ 6.95
J. 1963-1966 Parking Brake Pedal Pad	\$ 6.95

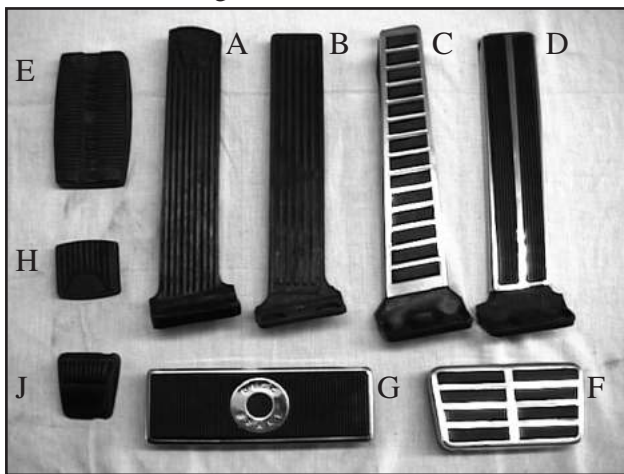

## Fresh Air Vents

1961-1963 Left Vent Cable Assy., w/o Knob	\$ 19.95
K. 1961-1963 Left Vent Cable Knob	\$ 19.95
L. 1961-1963 Left Vent Cable Bezel	\$ 25.00
M. 1961-1963 Left Vent Cable Bezel Nut	\$ 15.00
1961-1963 RH Vent Cable Assy., w/ Handle	\$ 49.95
N. 1961-1966 Fresh Air Inlet Seal, with AC	\$ 40.00
P. 1961-1966 Fresh Air Inlet Seal, without AC	\$ 10.00
1964-1966 Vent Cable, Left or Right, used	\$ 30.00
1964-1966 Vent Cable Knobs, used, each	\$ 5.00

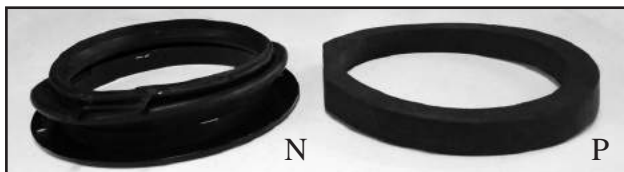

## Glass

### Front Windshields:

1958-1960 Clear or Tinted, new	\$580.00
1961-1963 Clear or Tinted, new	\$390.00
1964-1966 Clear or Tinted, new	\$220.00

### Door Glass:

1958-1960 Clear or Tinted, new	\$ 70.00
1961-1963 Clear or Tinted, new	\$195.00
1964-1966 Clear or Tinted, new	\$ 75.00

### Vent Window Glass:

1958-1960 Clear or Tinted, new	\$ 30.00
1961-1963 Clear or Tinted, new	\$ 85.00
1964-1966 Clear or Tinted, new	\$ 30.00

### Quarter Window Glass:

1958-1960 Clear or Tinted, new	\$ 50.00
1961-1963 Clear or Tinted, new	\$ 99.00
1964-1966 Hard Top, Clear or Tinted, new	\$ 50.00
1964-1966 Convertible, Clear or Tinted, new	\$ 50.00

### Rear Windshields:

1958-1960 Clear or Tinted, new	\$480.00
1961-1963 Clear or Tinted, new	\$580.00
1964-1966 Hard Top, Clear or Tinted, new	\$480.00
1966 Landau & Town HT, Clear or Tinted, new	\$480.00

### Used Glass:

1958-1966 Front Windshields	CALL
1958-1960 Door Glass	\$ 70.00
1961-1963 Door Glass	\$ 70.00
1964-1966 Door Glass	\$ 70.00
1958-1960 Vent Window Glass	\$ 30.00
1961-1963 Vent Window Glass	\$ 75.00
1964-1966 Vent Window Glass	\$ 30.00
1958-1960 Quarter Window Glass	\$ 50.00
1961-1963 Quarter Window Glass	\$ 75.00
1964-1966 Hard Top Quarter Window Glass	\$ 50.00
1964-1966 Convertible Quarter Window Glass	\$ 50.00
1958-1966 Rear Windshields	\$200.00

**Front and rear windshields are shipped via truck freight. Most new glass is shipped directly from the manufacturer to reduce shipping costs.**

## Vent Window / Door Glass Channels

1958-1960 Pair	\$ 60.00
1964-1966 Pair	\$ 60.00
1958-1966 Moleskin Lining	\$ 7.00

# Interior Parts

## Sunvisors

1958-1959 White, new, pair	\$120.00
1960 Specify color, new, pair	\$120.00
1961-1963 Hardtop, used	CALL
1961-1963 Convertible, used	CALL
1964-1966 Hardtop, used	CALL
1964-1966 Convertible, used	CALL

(All sunvisors are sold without brackets)



## Interior Screw Kits

Most Comprehensive Screw Kits on the market.  
 1958-1966 Hard Top, Landau, or Convertible. \$ 55.00  
 Specify Year and model.

**We also have a large selection of exterior screws! Please call for details.**

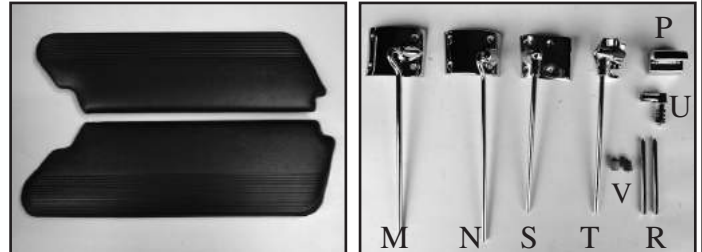

## Sunvisor Arms and Brackets

M. 1958-1960 Hardtop and Convertible, L or R	\$ 50.00
1958-1960 Sunvisor Clips, each	\$ 15.00
N. 1961-1963 Hardtop or Convertible, L or R	\$ 50.00
P. 1961-1963 Visor Arm Center Clip	\$ 20.00
R. 1961-1966 Visor Anchor Pins, each	\$ 4.00
S. 1964-1966 Convertible, Left or Right	\$ 50.00
T. 1964-1966 Hardtop, Left or Right	\$ 25.00
U. 1964-1966 Pivot Repair Kits	\$ 12.00
V. 1966 Landau Visor Arm Tips, each	\$ 2.00

## Headliners

1958-1960 Like Original; White, Black, or Bone	\$ 59.95
1961-1963 Like Original; White, Black, or Bone	\$ 59.95
1964-1966 Like Original; White, Black, or Bone	\$ 59.95
1961-1966 Headliner Tacking Strip Set	\$ 35.00

## Landau Vinyl Tops

1962-1963 Cobra grain, as original, black only	\$199.00
1962-1963 Levant grain, black or white	\$199.00
1964-1965 Cobra grain, as original, black only	\$199.00
1964-1965 Levant grain, black or white	\$199.00
1966 Levant Grain, as original, black or white	\$199.00

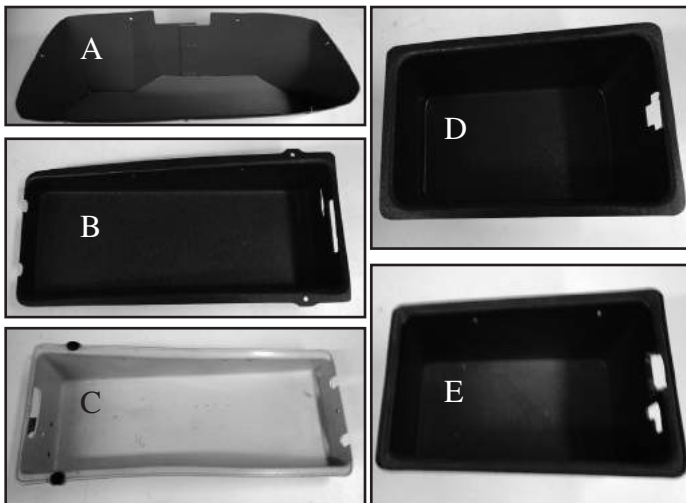

## Glove Box Liners

A. 1958-1960 Gray Cardboard Liner, new	\$ 18.00
B. 1961-1963 Black Plastic Liner, new	\$ 60.00
C. 1962-1963 White Plastic Liner, used	\$ 60.00
D. 1964-1966 Black Plastic Liner, new	\$ 60.00
E. 1964-1965 Black Plastic Liner, used	\$ 40.00
1966 Black Plastic Liner, used	\$ 40.00

## Door Sill Plates

F. 1958-1960 Left and Right	\$120.00
G. 1961-1962 Left and Right	\$149.95
H. 1963 Left and Right	\$110.00
J. 1964-1966 Left and Right	\$ 99.95
K. 1963-1966 Sill Plate Decals, pair	\$ 5.00
L. 1958-1966 Sill Plate Screw Kits	\$ 2.50



**For monthly specials, please visit our website: [www.wilsonsbird.com](http://www.wilsonsbird.com)**

# Steering Column/Shifter Parts

## Steering Wheels

- A. 1958-1960 White Steering Wheel, new \$299.95
- B. 1958-1960 Horn Ring \$139.00
- C. 1958-1960 Wheel Center Insert, Black \$ 24.00
- D. 1959-1960 Wheel Center Insert, White \$ 24.00
- E. 1958-1960 Wheel Spoke Chrome Inserts, Set \$ 40.00
- 1961-1963 Steering Wheels, used CALL
- 1964-1966 Steering Wheels, used CALL

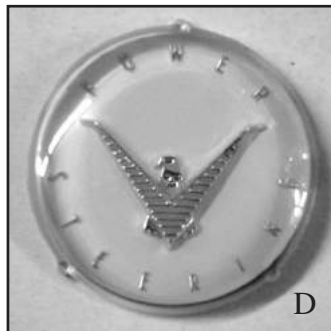
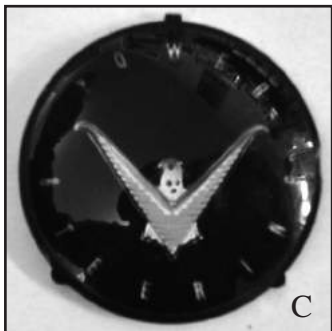
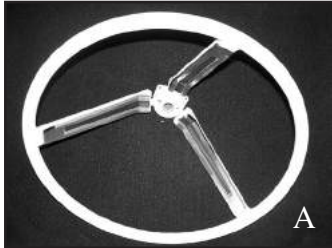

## Shift Collars

- F. 1958-1960 New \$ 99.95
- 1961-1963 New \$ 99.95
- G. 1964-1966 New \$ 99.95



We also carry a large selection of used steering columns and everything needed to repair the swing-away steering columns on the 1961-1966 Thunderbirds.

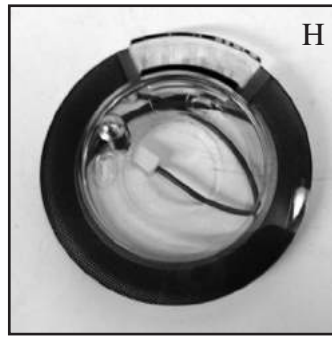

## Transmission Gear Indicators

- H. 1958 Black Face, with Horn Contact, new \$49.95
- J. 1959 Gold Face, with Horn Contact, new \$49.95
- 1960 Silver Face, with Horn Contact, new \$49.95
- 1961-1963 Black Face, new, Horn Contact sold sep. \$49.95
- K. 1964-1966 Chrome Housing, Clear Face, new \$24.00



## Turn Signal Levers

- L. 1958 Black Handle with Silver Insert \$15.00
- M. 1959 White Handle with Gold Insert \$15.00
- N. 1960 White Handle with Silver Insert \$15.00
- P. 1961-1962 Chrome \$15.00
- Q. 1962-1966 Chrome \$15.00





# Steering Column/Shifter Parts

## Shift Levers and Parts



Car won't stay in Park, or jumps out of Park? Indicator alignment is off? Sloppy shift tube? Steering wheel moves from side to side or up and down? This is a Safety Hazard! These parts can help solve these problems.

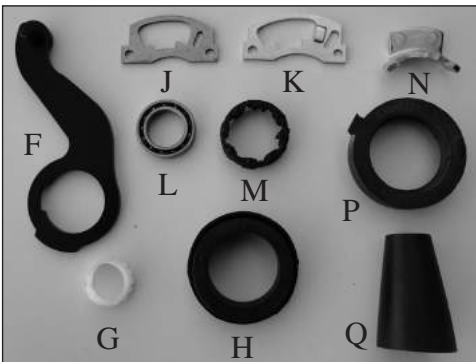

A. 1958 Shift Handle, Black Knob with Silver Insert	\$ 39.95
B. 1959 Shift Handle, White Knob with Gold Insert	\$ 39.95
C. 1960 Shift Handle, White Knob with Silver Insert	\$ 39.95
D. 1961-1963 Shift Handle, Chrome	\$ 49.95
E. 1964-1966 Shift Handle, Chrome	\$ 49.95
F. 1958-1960 Shift Selector Arm	\$ 30.00
G. 1958-1960 Upper Steering Shaft Bushing	\$ 8.50
H. 1958-1960 Lower Shift Tube Bushing	\$ 10.00
J. 1958-1960 Detent Plate	\$ 25.00
K. 1961-1963 Detent Plate	\$ 25.00
L. 1961-1966 Upper Steering Shaft Bearing	\$ 19.00
M. 1961-1966 Upper Steering Shaft Bushing	\$ 9.00
N. 1964-1966 Detent Plate	\$ 16.00
P. 1964-1966 Lower Shift Tube Bushing	\$ 10.00
Q. 1964-1966 Steering Column Dust Shield	\$ 14.00

# Steering and Suspension

## Front End Rebuilding Kit

1958-1960 Standard Kit	\$325.00
1958-1960 Deluxe Kit	\$450.00
1961-1966 Standard Kit	\$450.00
1961-1966 Deluxe Kit	\$525.00

### Standard Kit Includes

- 2 Upper Ball Joints
- 2 Lower Ball Joints
- 2 Stabilizer End Link Kits
- 2 Outer Tie Rod Ends
- Lower Control Arm Bushings
- Upper Control Arm Bushings
- 2 Strut Rod Bushings

### Deluxe Kit Includes

- 2 Upper Ball Joints
- 2 Lower Ball Joints
- 2 Stabilizer End Link Kits
- 2 Outer Tie Rod Ends
- Lower Control Arm Bushings
- Upper Control Arm Shafts and Bushings
- 2 Strut Rod Bushings



1966 Deluxe Front End Kit parts purchased separately would total \$647.00! Save time and money by purchasing the complete kit!

## Ball Joints

R. 1958-1960 Lower, each	\$ 75.00
S. 1958-1960 Upper, each	\$ 30.00
T. 1961-1962 Upper, pair only	\$130.00
U. 1961-1966 Lower, each	\$ 65.00
V. 1963-1966 Upper, each	\$ 65.00
1967-1972 Lower, each	\$ 45.00
1967-1972 Upper, each	\$ 35.00

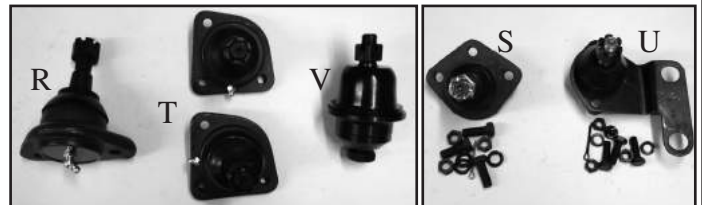

## Tie Rod Ends

1958-1960 Outer	\$ 25.00
1958-1960 Inner, Right or Left	\$ 79.00
1961-1964 Outer	\$ 47.00
1961-1964 Inner	\$ 65.00
1965-1966 Outer	\$ 47.00
1965-1966 Inner	\$ 65.00
1958-1966 Tie rod connecting sleeve	\$ 12.00



For monthly specials, please visit our website: [www.wilsonsbird.com](http://www.wilsonsbird.com)

# Steering and Suspension

## Center Links (Drag Links)

- A. 1961-1962 \$110.00  
 1963-1964 \$110.00



## Control Arm Bushings and Shafts

- B. 1958-1960 Upper, 2 required per side, each \$ 15.00  
 C. 1958-1960 Lower, 2 required per side, each \$ 15.00  
 1958-1960 Lower Control Arm Pin, used, ea. \$ 20.00  
 D. 1961-1966 Upper, 2 required per side, each \$ 20.00  
 E. 1961-1966 Lower, 1 required per side, each \$ 15.00  
 F. 1958-1960 Upper Arm Shaft w/ Bushings, each \$ 89.95  
 G. 1961-1966 Upper Arm Shaft w/ Bushings, each \$ 75.00  
 H. 1961-1966 Alignment Shim, 1/32", 1/16", or 1/8", ea. \$ 3.50  
 J. 1958-1960 Upper Control Arm Bumper \$ 10.00  
 K. 1958-1960 Lower Control Arm Bumper \$ 10.00

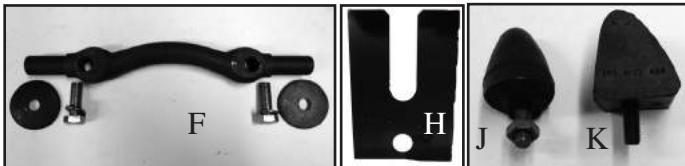
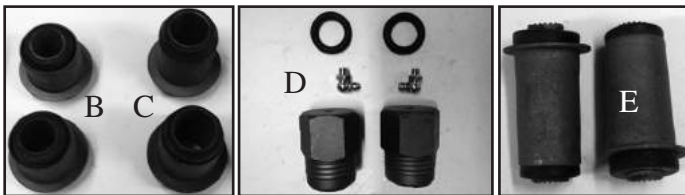

## Strut Rods

- 1961 Strut Rod Bushing Kit, L and R \$ 45.00  
 L. 1962-1966 Strut Rod Bushing Kit, L and R \$ 55.00  
 1961-1966 Strut Rods, used CALL

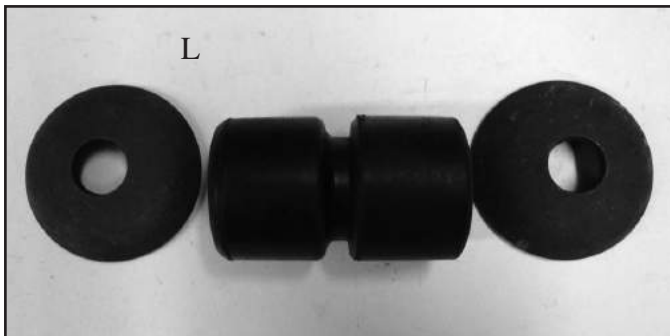

## Sway Bars

- M. 1958-1960 End Link Kit, pair \$ 24.00  
 N. 1961-1966 End Link Kit, pair \$ 24.00  
 P. 1958-1960 Insulator Bushing (on frame), each \$ 10.00  
 Q. 1958-1960 Insulator Bushing Bracket, new \$ 10.00  
 R. 1961-1966 Insulator Bushing (on frame), each \$ 10.00

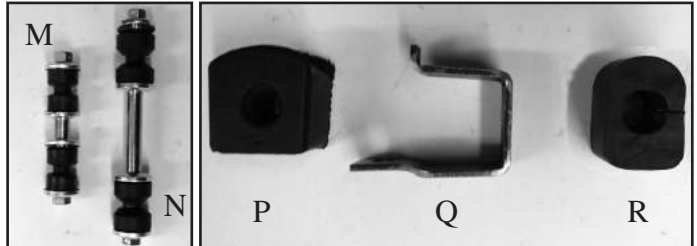

## Heavy Duty Sway Bar Kits

**They make a big difference in handling.**

- 1958-1960 Front, with all hardware \$250.00  
 1961-1963 Front, with all hardware \$250.00  
 1964-1966 Front, with all hardware \$250.00

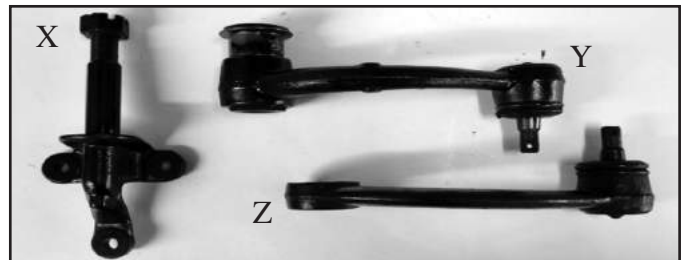
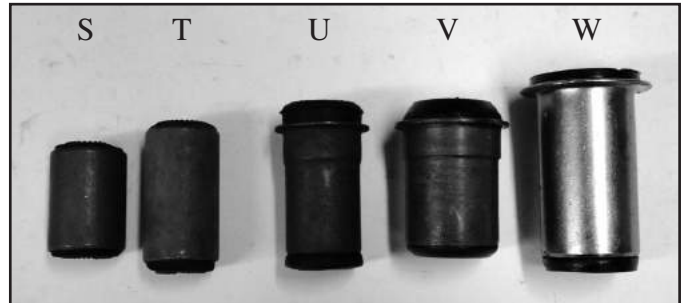

**Vague or loose steering could indicate worn idler arm bushings, be sure to check them frequently!**

## Idler & Pitman Arms

- S. 1958-1960 Idler Arm Bushing, upper, each \$ 20.00  
 T. 1958-1960 Idler Arm Bushing, lower, each \$ 20.00  
 1958-1960 Idler Arm Kit, w/ Power Steering \$ 59.00  
 1958-1960 Pitman Arm, used CALL  
 U. 1961-Early 1962 Idler Arm Bushing \$ 16.00  
 V. Late 1962-1963 Idler Arm Bushing \$ 30.00  
 1961-1964 Idler Arm Assembly, new \$250.00  
 1961-1964 Rebuilt Idler Arm Assembly \$125.00  
 Rebuilt Idler Arm sold as Exchange Only  
 1961-1964 Pitman Arm, used CALL  
 W. 1964-1966 Idler Arm Bushing \$ 30.00  
 X. 1964-1966 Idler Arm Bracket, used \$ 50.00  
 Y. 1965-1966 Idler Arm, new \$225.00  
 Z. 1965-1966 Pitman Arm, new \$130.00

# Steering and Suspension



## Front Coil Springs

- |  |          |
|--|----------|
| A. 1958-1960 Matched pair                    | \$195.00 |
| 1961-1963 17.5" with 9 Coils, Matched pair   | \$195.00 |
| 1963 19.5" with 11 Coils, Matched pair       | \$195.00 |
| 1964-1966 with AC, Matched pair              | \$195.00 |
| 1964-1966 without AC, Matched pair           | \$195.00 |
| B. 1961-1966 Front Spring Insulators, pair   | \$ 15.00 |
| C. 1961-1962 Spring Saddle Bushing Kit, each | \$ 50.00 |
| 1961-1962 Spring Saddle Brackets, pair       | \$ 30.00 |



## Rear Leaf Springs

- |                        |          |
|------------------------|----------|
| 1959-1960 Matched pair | \$350.00 |
| 1961-1963 Matched pair | \$350.00 |
| 1964-1966 Matched pair | \$350.00 |

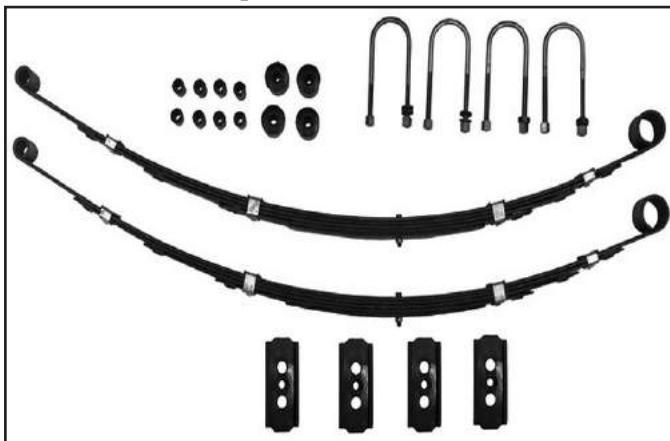

## Rear Leaf Spring Kits

- |                           |          |
|---------------------------|----------|
| 1959-1960 Leaf Spring Kit | \$448.00 |
| 1961 Leaf Spring Kit      | \$532.00 |
| 1962-1966 Leaf Spring Kit | \$512.00 |

**Each Spring Kit contains:**

**2 Leaf Springs, 4 U-Bolts w/ nuts, 4 Spring Pads, 4 Front Bushings (8 on 1961 Kits), and 8 Rear Bushings**

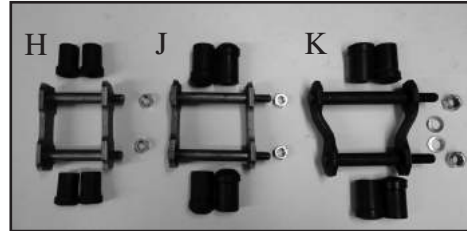
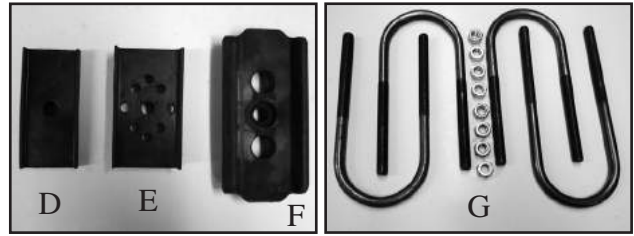

## Rear Spring Bushings and Pads

- |   |         |
|---|---------|
| D. 1959-1960 Spring pads, 4 required, each    | \$ 6.00 |
| E. 1961 Spring Pads, 4 required               | \$17.00 |
| F. 1962-1966 Spring pads, 4 required, each    | \$12.00 |
| G. 1959-1966 Spring U-Bolts, 4 required, each | \$12.00 |
| 1959-1960 Front of Spring, 4 required, each   | \$12.00 |
| 1959-1960 Rear of Spring, 8 required, each    | \$ 3.25 |
| 1961 Front of Spring, 8 required, each        | \$ 3.25 |
| 1962-1963 Front of Spring, 4 required, each   | \$10.00 |
| 1961-1963 Rear of Spring, 8 required, each    | \$ 3.25 |
| 1962-1966 Front Bushing Mounting Bolt         | \$19.95 |
| 1964-1966 Front of Spring, 4 required, each   | \$10.00 |
| 1964-1966 Rear of Spring, 8 required, each    | \$ 3.25 |
| H. 1959-1960 Shackle Kit, pair                | \$30.00 |
| J. 1961-1963 Shackle Kit, each, 2 Required    | \$38.00 |
| K. 1964-1966 Shackle Kit, each, 2 Required    | \$45.00 |

## Heavy Duty Gas Shocks

- |   |         |
|---|---------|
| 1958 Front, each                              | \$42.00 |
| L. 1959-1960 Front, each                      | \$42.00 |
| 1958 Rear, each                               | \$42.00 |
| 1959-1963 Rear, each                          | \$42.00 |
| 1961-1962 Front, each                         | \$42.00 |
| M. 1963 Front, each                           | CALL    |
| N. 1964-1966 Front, each                      | \$59.95 |
| P. 1964-1966 Rear, each                       | \$42.00 |
| Q. 1964-1966 Front Upper Top Bushing, each    | \$12.00 |
| R. 1964-1966 Front Upper Bottom Bushing, each | \$12.00 |
| S. 1963-1966 Front Shock Lower Mount, each    | \$20.00 |

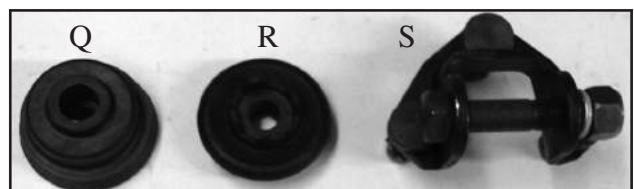
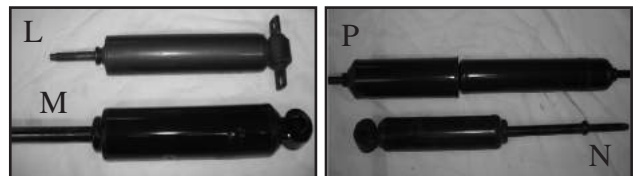

For monthly specials, please visit our website: [www.wilsontbird.com](http://www.wilsontbird.com)



# Steering and Suspension

## Power Steering Boxes and Parts

A. 1961-1964 Rebuilt Power Steering Box	\$370.00
1965-1966 Rebuilt Power Steering Box	\$370.00
Core Charge on all Power Steering Boxes	\$150.00
B. 1961-1966 Steering Box Insulators, new, each	\$ 45.00
1961-1966 Steering Box Insulators, used, each	\$ 20.00
C. 1961-1964 Steering Box Seal Kit	\$ 65.00
1965-1966 Steering Box Seal Kit	\$ 50.00
D. 1961-1964 Sector Shaft Seals, pair	\$ 16.00
1965-1966 Sector Shaft Seal Kit	\$ 16.00
1961-1964 Upper Shaft Seal	\$ 9.00
1965-1966 Upper Shaft Seal	\$ 17.00
E. 1962-1966 Rag Unit Repair Kit	\$ 19.00

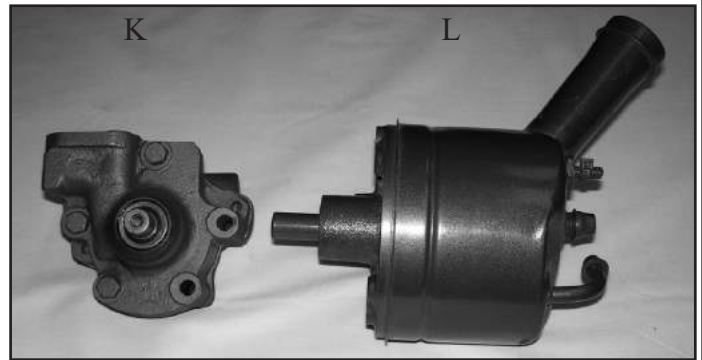
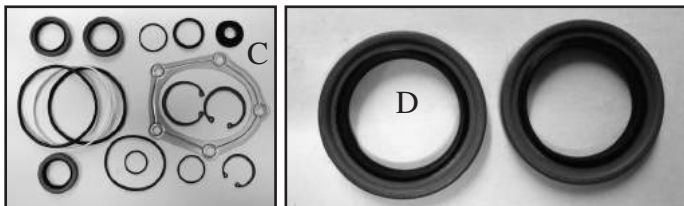
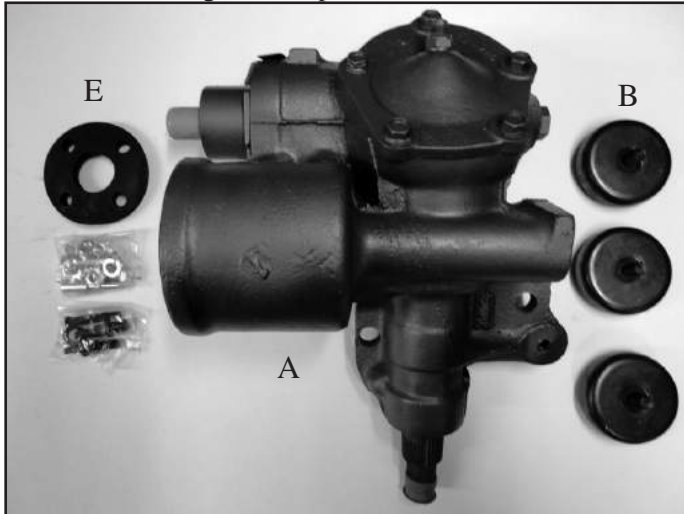

## Power Steering Pumps

K. 1958-1960 Rebuilt Eaton Pump	\$125.00
1961-1965 Rebuilt Eaton Pump	\$125.00
L. 1965-1966 Rebuilt Ford Pump, Large Neck	\$149.00
1965-1966 Rebuilt Ford Pump, Small Neck	\$125.00
Core Charge on all Power Steering Pumps	\$100.00

**Badly dented tanks will not be accepted as cores.**

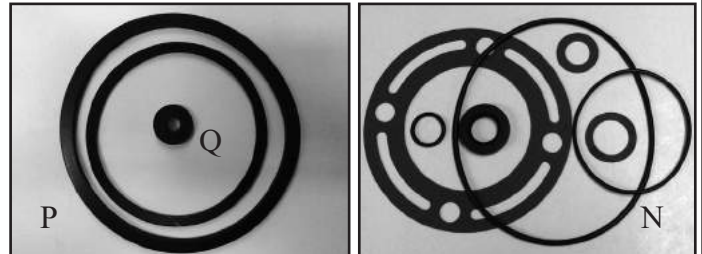
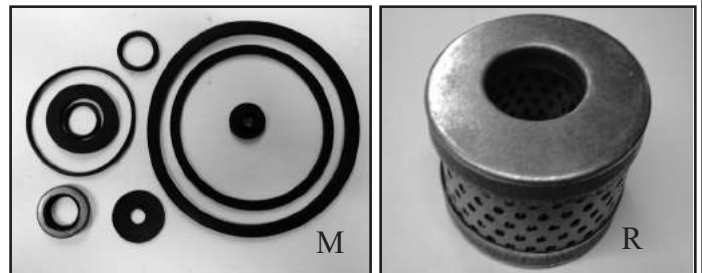

## Power Steering Control Valves

1958-1959 Rebuilt Control Valve	\$195.00
F. 1960 Rebuilt Control Valve	\$195.00
Core Charge on rebuilt Control Valves	\$250.00
1958-1960 Control Valve Ball Stud Repair Kit	\$ 55.00
1958-1960 Control Valve Ball Stud Sleeve	\$ 19.00

**Do not use a pickle fork to remove. No credit will be given for damaged barrel housings.**

## Power Steering Ram Cylinders

G. 1958-1960 Rebuilt Ram Cylinder	\$175.00
Core Charge on rebuilt Ram Cylinders	\$100.00
1958-1960 New Ram Cylinder	\$250.00
H. 1958-1960 Cylinder Mount Kit, Frame End	\$ 7.00
J. 1958-1960 Cylinder Mount Kit, Link End	\$ 4.00
1958-1960 Cylinder Mount Kit, Both Ends	\$ 10.00
1958-1960 Ram Cylinder Seal Kit	\$ 16.00

**All cores must be fully drained.**

## Power Steering Pump Parts

M. 1958-1965 Eaton Pump Seal Kit	\$ 16.50
N. 1965-1966 Ford Pump Seal Kit	\$ 15.00
P. 1958-1964 Reservoir Lid Gasket	\$ 2.50
with or without AC	
Q. 1958-1964 Reservoir Lid Washer	\$ 1.00
R. 1958-1964 Power Steering Fluid Filter	\$ 22.00
1958-1964 PS Filter Washer and Spring Assy.	\$ 25.00



# Steering and Suspension

## Power Steering Lines and Hoses

A. 1958-1960 Pressure Hose	\$ 35.00
B. 1958-1959 Cylinder to Control Valve Hoses, pr.	\$ 40.00
C. 1960 Cylinder to Control Valve Steel Lines, pr.	\$ 40.00
D. 1958-1960 P/S Pump Return Hose w/ Fitting	\$ 20.00
E. 1961-1963 Pressure Hose	\$ 47.00
F. 1961-1962 Return Steel Line	\$ 15.00
G. 1961-1962 Return Hose with Clamps	\$ 10.00
1963 Steel Return Line, 2-Piece Set	\$ 28.00
H. 1963 Power Steering Box to Wiper Hose	\$ 40.00
1963 Return Hose with Clamps	\$ 18.00
J. 1964 Pressure Hose	\$ 50.00
K. 1965-1966 Pressure Hose	\$ 47.00
L. 1965-1966 Pump to Hose Steel Line	\$ 15.00
M. 1964 Power Steering Box to Wiper Hose	\$ 40.00
N. 1965-1966 Power Steering Box to Wiper Hose	\$ 40.00
P. 1964-1966 Return Hose with Clamps	\$ 18.00

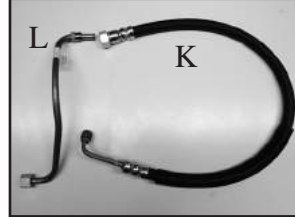
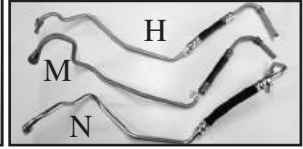
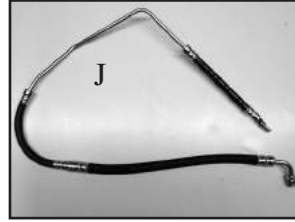
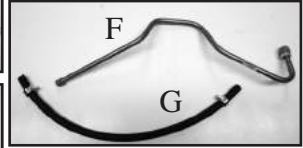
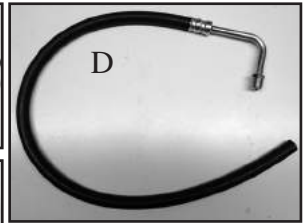

# Mechanical Parts

## Radiators

1958-1960	\$399.95
1961	\$399.95
1962-1963	\$399.95
1964-1965	\$399.95
1966 with 17" core	\$399.95
1966 with 19" core	\$399.95

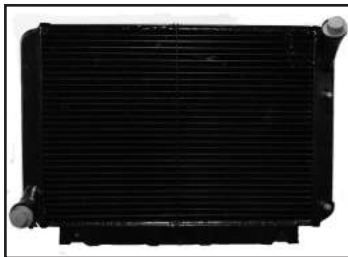

## Expansion Tanks

Q. 1958-1960 New	\$199.95
1959-1960 with 430, new	\$199.95
1961-1964 New	\$199.95
R. 1965-1966 New	\$199.95
1958-1966 Used, Pressure Tested	\$ 90.00
S. 1958-1966 Radiator Pressure Cap (Zinc or chrome)	\$ 20.00
T. 180° Thermostat	\$ 9.00
160° Thermostat	\$ 9.00
U. Thermostat Gasket	\$ 2.00

## Radiator Hoses

1958-1966 Upper or Lower, FoMoCo Script	\$ 19.95
1958-1966 Upper or Lower, No Script	\$ 15.95
1958-1966 Hose Clamps (Tower Style), 10-pc.set	\$ 28.00

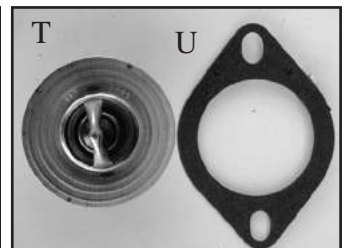

For monthly specials, please visit our website: [www.wilsonbird.com](http://www.wilsonbird.com)

# Mechanical Parts

## Heater Cores

- A. 1958-1960 Heater Core, new \$119.95
- B. 1961-Early 1962 Heater Core, 2-Stud, new \$119.95
- C. Late 1962-1963 Heater Core, 3-Stud, new \$119.95
- D. 1964-1966 Heater Core, without AC, new \$119.95
- E. 1964-1966 Heater Core, with AC, new \$119.95
- 1964-1966 Heater Control Valve, with AC, new \$ 40.00
- F. 1958-1963 Heater Control Valve Kit, \$ 79.00  
replacement, with External Valve
- G. 1961-1963 Heater Control Valve, replacement, \$ 55.00  
mounts on Heater Core as Original

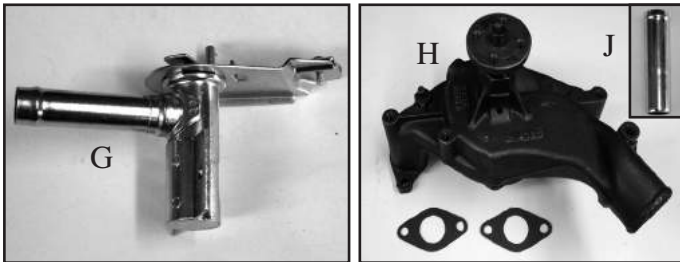
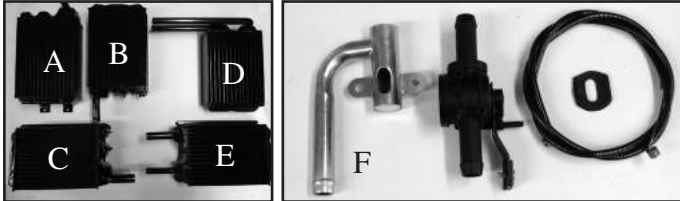

## Cooling System Parts

- 1958-1960 Water Pump, new \$129.95
- 1961-1964 Water Pump, new \$ 99.95
- H. 1965-1966 Water Pump, new \$ 99.95
- J. 1960-1966 Manifold/Water Pump Bypass Tube \$ 4.00
- K. 1958-1959 Bypass Hose Fitting, \$ 25.00  
w/ Temperature Sender Mounting Boss
- L. 1958-1960 Water Pump Heater Hose Inlet \$ 7.00
- M. 1958-1961 Manifold Heater Hose Outlet, used \$ 10.00
- N. 1958-1960 Heater Hose Clamps, each \$ .50
- P. 1961-1966 Water Pump Heater Hose Inlet \$ 7.00
- Q. 1962-1966 Heater Hose Manifold Y-Fitting \$ 20.00
- R. 1962-1966 Heater Hose Y-Pipe \$ 12.00
- S. 1962-1965 Heater Hose J-Pipe \$ 15.00

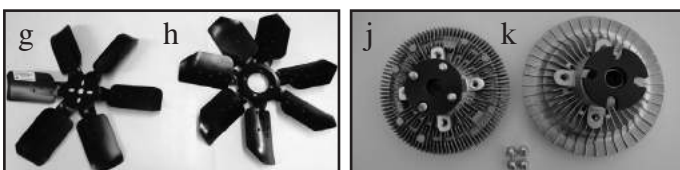
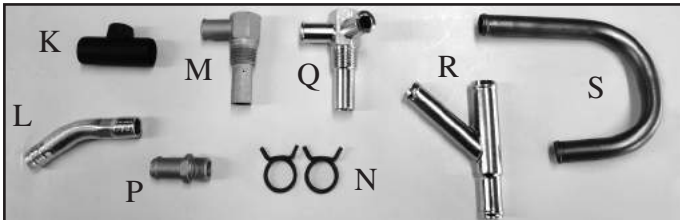

## Battery Trays

- T. 1958-1960 with Bracket \$ 55.00
- U. 1961-1966 (Group 29) Bottom hold down \$ 27.50
- V. 1966 (Group 24) Top hold down \$ 25.75

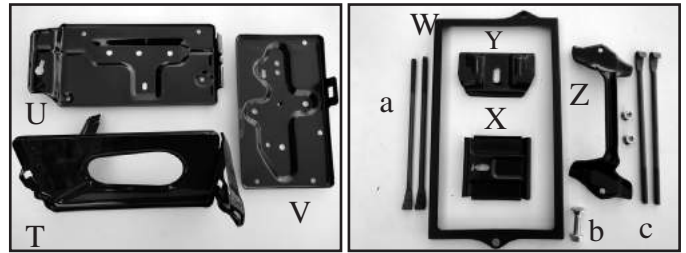

## Battery Hold Downs

- W. 1958-1960 with Group 27 Battery \$ 35.00
- 1958-1960 with Group 29 Battery \$ 26.00
- X. 1961-1963 (Group 27) Bottom Hold Down \$ 5.25
- Y. 1961-1966 (Group 29) Bottom Hold Down \$ 5.25
- Z. 1966 (Group 24) Top Hold Down \$ 12.75
- a. 1958-1960 Bolts for Top Hold Down, pair \$ 6.00
- b. 1961-1966 Bolt for Bottom Hold Down \$ 2.00
- c. 1966 Bolts for Top Hold Down, pair \$ 6.00

## Air Cleaners

- 1958-1960 Air Cleaner with 352, used CALL
- 1959-1960 Air Cleaner with 430, used CALL
- 1959-1960 Air Cleaner Snorkel, used CALL
- 1961-1963 Air Cleaner, used CALL
- 1962-1963 Tri-Power Air Cleaner Emblem \$ 35.00
- 1964 Air Cleaner, used CALL
- 1965 Air Cleaner, used CALL
- 1965-1966 Air Cleaner Lid Gasket, new \$ 5.25
- 1966 Air Cleaner, used CALL
- 1958-1966 Filter Element \$ 12.00

## Fan Shrouds and Fan Parts

- d. 1958-1960 Fan Shroud **NEW** \$180.00
- e. 1961-1965 Fan Shroud, 2-Piece, new \$ 99.95
- 1961-1965 Fan Shroud, 2-Piece, used \$ 50.00
- f. 1966 Fan Shroud, Fiberglass, 17", new \$130.00
- 1966 Fan Shroud, Fiberglass, 19", new \$130.00
- 1958-1960 Fan, 4-Blade, without AC, used \$ 50.00
- 1961-1966 Fan, 5-Blade, without AC, used \$ 50.00
- g. 1958-1966 Fan, 6-Blade, without AC, new \$ 69.00
- h. 1961-1966 Fan, 7-Blade, with AC, used \$130.00
- j. 1961-1963 Fan Clutch, with AC, new \$ 71.50
- k. 1964-1966 Fan Clutch, with AC, new \$ 70.00
- 1958-1966 Fan Spacers, used \$ 25.00

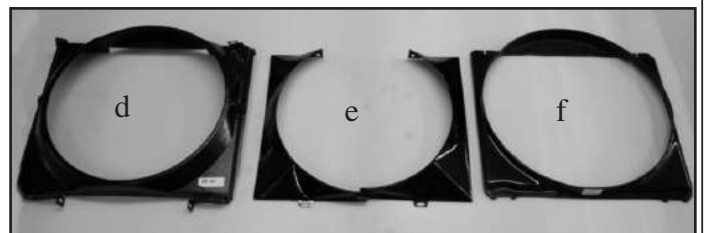



# Mechanical Parts

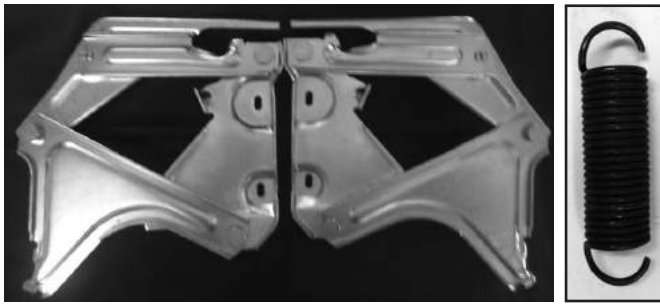

## Hood Hinges

1958-1960 Left or Right, with Spring, used	\$ 75.00
1961-1966 Left or Right, with Spring, used	\$ 75.00
1961-1966 New, without Springs, pair	\$215.00
1961-1966 Hood Hinge Spring, new	\$ 19.00

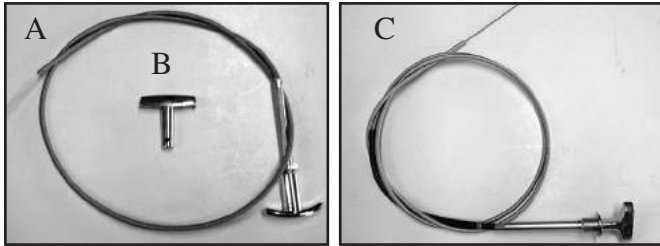

## Hood Release Cable

A. 1958-1962 Replacement	\$ 24.00
1958-1960 Latch to Latch Cable	\$ 12.00
B. 1958-1960 Hood Release Handle, new	\$ 17.00
C. 1961-1962 Like Original	\$ 50.00

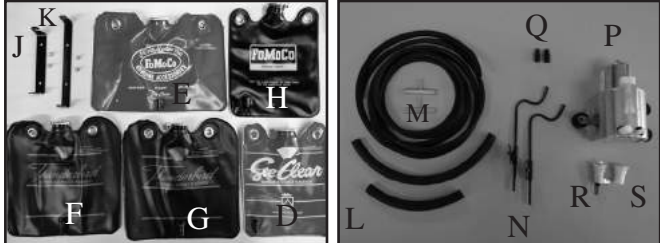

## Windshield Washer Parts

D. 1958-1960 Washer Bag, with cap	\$ 35.00
E. 1961-1963 Washer Bag, with cap	\$ 35.00
F. 1964-1965 Washer Bag, with cap	\$ 35.00
G. 1966 Washer Bag, with cap	\$ 35.00
H. 1958-1966 Washer Bag Replacement (FoMoCo)	\$ 19.00
1958-1965 Washer Bag Cap	\$ 3.50
J. 1958-1960 Washer Bag Bracket	\$ 12.95
1961-1963 Washer Bag Bracket	\$ 12.95
K. 1964-1966 Washer Bag Bracket, replacement	\$ 12.95
L. 1958-1966 Washer Hose Kits	\$ 15.00
M. 1958-1966 Washer Hose T-Fitting	\$ 1.50
1958-1960 Washer Nozzles, new, pair	\$ 25.00
1961-1963 Washer Nozzles, new, pair	\$ 25.00
N. 1964-1966 Washer Nozzles, used	CALL
P. 1961-1966 Washer Pump	\$ 40.00
Q. 1965-1966 Washer Nozzle Tips, pair	\$ 5.00
R. 1964-1966 Washer Switch Assembly	\$ 19.95
S. 1964-1966 Washer Switch Repair	\$ 10.00

## Door & Trunk Hinges

1958-1966 Door Hinges, used, per door	\$ 55.00
1958-1966 Door Hinge Pins, each	\$ 2.00
1958-1966 Door Hinge Pin Bushings, each	\$ 1.50
1958-1966 Hardtop Trunk Hinges, used, each	\$ 75.00
1961-1966 HT Trunk Hinge Torsion Bars, used, pr.	\$ 50.00
1958-1966 Convertible Trunk Hinges, used, each	CALL

## Hood Pad Sets

1958-1960 Tar Felt like Original	\$ 45.00
1961-1963	\$ 45.00
1964-early 1965	\$ 45.00
Late 1965	\$ 45.00
1966	\$ 45.00
Spray Adhesive for Hood Pad sets	\$ 10.00

1961-1966 hood pad sets are fiberglass as original.

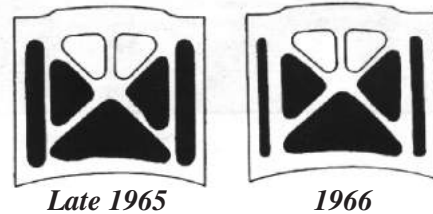

## Starter Motors and Starter Parts

T. 1958-1961 Rebuilt Starter Motor without Drive	\$119.00
1961-1964 Rebuilt Starter Motor without Drive	\$119.00
1965-1966 Rebuilt Starter Motor with Drive	\$ 89.00
1958-1964 Core Charge on all Starter Motors	\$ 75.00
U. 1958-1964 Bell Housing to Starter Seal	\$ 19.00
V. 1958-1960 Starter Drive	\$ 59.00
W. 1961-1964 Starter Drive	\$ 59.00
X. 1965-1966 Starter Drive	\$ 23.00

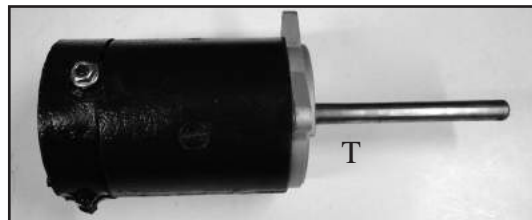

# Mechanical Parts

## Valve Covers

- 1958-1960 Used, pair CALL
- 1961-1964 Used, pair CALL
- A. 1958-1964 Chrome Valve Cover, 352-390, \$140.00  
w/o Lettering, new, pair
- 1965-1966 Used, pair CALL
- 1958-1966 Gasket, each \$ 10.00



## Oil Pans and Related Parts

- K. 1958-1966 New Oil Pan 352, 390, 428 \$79.00
- L. 1958-1966 Chrome Oil Pan, new \$89.00
- 1958-1966 Oil Drain Plug \$ 2.50
- 1958-1966 Drain Plug Washer \$ .50
- 1958-1966 Oil Pan Gasket \$20.00
- M. 1958-1966 Oil Filter Adapter, new \$50.00
- 1958-1966 Oil Filter Adapter, used \$25.00
- N. 1958-1966 Oil Filter Adapter Gasket \$ 2.00
- 1958-1966 Replacement Oil Filter \$ 3.50
- 1958-1966 Motorcraft Oil Filter \$ 7.00
- P. 1958-1963 Oil Pressure Switch \$16.50
- Q. 1964-1966 Oil Pressure Sending Unit \$24.00

## Road Draft Tubes

- 1958-1961 Road Draft Tube, used \$ 70.00

## PCV System

- B. 1961-1964 Rear Intake Hose Nipple, new \$ 27.00
- C. 1961-1964 PCV Valve 10.00
- 1961-1964 PCV Steel Lines, used CALL
- 1961-1965 Carburetor Spacer Plate, used \$ 55.00
- D. 1965-1966 PCV Valve \$ 9.00
- E. 1965-1966 PCV Valve Cover Grommet \$ 5.00
- F. 1965-1966 PCV Hose \$ 15.00

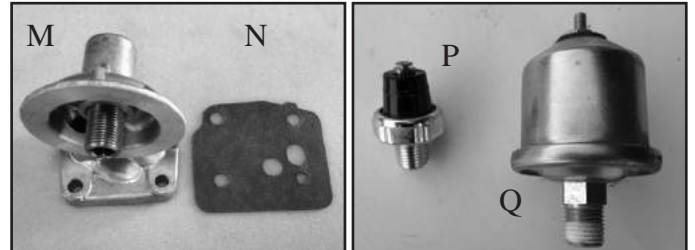
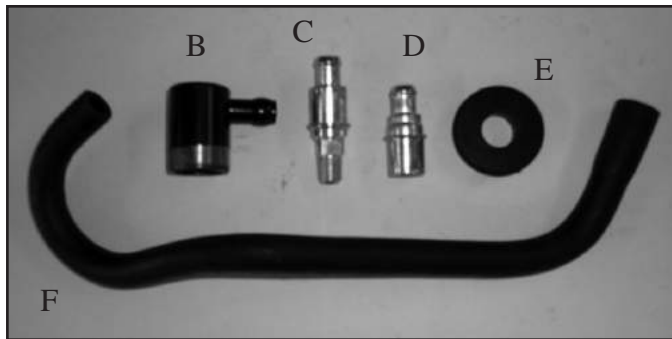

## Oil Filler Caps

- G. 1958-1964 Like Original, black \$ 15.00
- H. 1958-1964 Like Original, chrome \$ 15.00
- J. 1965-1966 Same as Original \$ 15.00



## Oil Dipsticks and Tubes

- 1958-1960 Dipstick 352 cu. in. \$21.00
- R. 1961-1964 Dipstick \$21.00
- 1965 Dipstick \$21.00
- 1966 Dipstick \$21.00
- 1958-1960 Tube \$21.00
- S. 1961-1964 Tube \$21.00
- 1965 Tube \$21.00
- 1966 Tube \$21.00



# Mechanical Parts

## Motor Mounts

A. 1959-1960 with 430, Upper, Left or Right	\$45.00
B. 1959-1960 with 430, Lower	\$ 8.00
C. 1958-1960 with 352	\$28.00
1961-1963 with 390	\$28.00
D. 1964-1966 with Cruise-O-Matic Trans., L or R	\$40.00
1966 with C6 Transmission and/or 428	\$28.00
E. 1961-1966 Motor Mount Brackets, new, each	\$35.00
1961-1966 Motor Mount Brackets, used, each	\$20.00
F. 1958-1966 Motor Mount Heat Shield, Left only	\$12.00

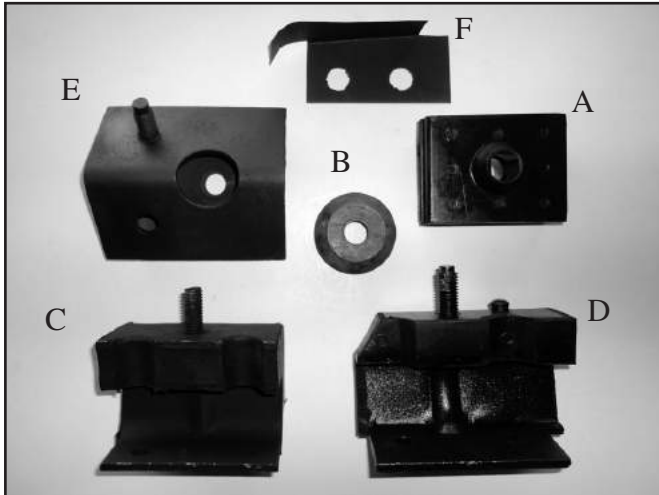

## Transmission Mounts

G. 1958-1960 Transmission Mount, with 352	\$29.50
H. 1959-1960 Transmission Mount, with 430	\$44.95
J. 1961-1963 Transmission Mount	\$27.00
K. 1964-1966 Trans. Mount, with Cruise-O-Matic	\$24.00
L. 1966 Transmission Mount, with C6	\$33.00

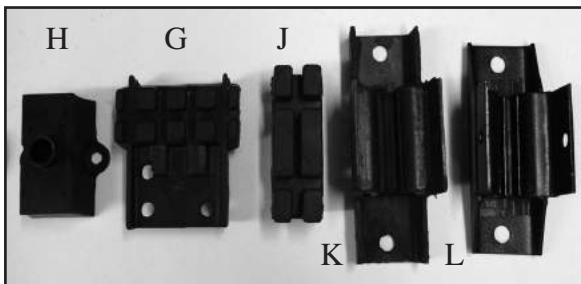

## Transmission Kick Down Rods

1961-1966 with Cruise-O-Matic Transmission	\$49.95
1966 with C6 Transmission	\$49.95
1961-1966 Cruise-O-Matic or C6, used	\$25.00

## Transmission Cooling Lines

	Steel	Stainless
1958-1960 Cooling Lines, 2 piece set	\$65.00	\$105.00
1961 Cooling Lines, 4 piece set	\$65.00	\$105.00
1962-1963 Cooling Lines, 4 piece set	\$65.00	\$105.00
1964-1966 w/ Cruise-O-Matic, 4 pc. set	\$65.00	\$105.00
1966 w/ C6 Cooling Lines, 4 piece set	\$65.00	\$105.00
1961-1966 w/ Cruise, Modulator Line	\$20.00	N/A
1966 with C6, Modulator Valve Line	\$20.00	N/A

## Transmission Dipsticks

M. 1958-1966 Dipstick Tube, used	\$ 70.00
1958-1959 Dipstick	\$ 25.00
1961 Dipstick	\$ 25.00
N. 1962-1965 Dipstick	\$ 25.00
1966 Cruise-o-Matic Dipstick	\$ 25.00
P. 1966 C6 Dipstick Tube, used	\$ 40.00
Q. 1966 C6 Dipstick	\$ 25.00
R. 1966 C6 Dipstick Tube O-ring	\$ 1.00
1958-1966 Dipstick, used	\$ 20.00



## Transmission Parts

1958-1960 Transmission Pan, used	\$ 80.00
1961-1966 Transmission Pan, used	\$ 80.00
1966 C6 Transmission Pan, used	\$ 40.00
S. 1966 C6 Transmission Pan, Chrome, new	\$ 45.00
1958-1960 Transmission Pan Gasket	\$ 6.00
1961-1966 Transmission Pan Gasket	\$ 6.00
1961-1966 Cruise-O-Matic Filter & Gasket Set	\$24.95
1966 C6 Transmission Pan Gasket	\$ 6.00
1961-1966 Front Pump Seal	\$ 12.00
T. 1961-1966 Tailshaft Seal	\$ 12.95
U. 1966 C6 Front Pump Seal	\$ 12.00
V. 1966 C6 Tailshaft seal	\$ 12.00
1958-1966 Modulator Valve	\$ 29.00
W. 1961-1966 Trans. Cooler Line Link Hoses, pr.	\$ 14.00

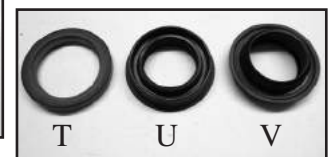
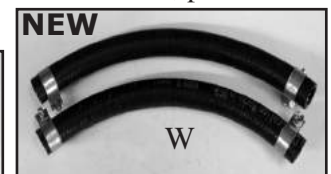

## Engine Gaskets and Seals

Complete Engine Gasket Set: 352, 390, or 428	\$130.00
Intake Manifold Gasket Set	\$ 27.00
Oil Pan Gasket Set	\$ 25.00
Timing Cover Gasket Set	\$ 42.00
Exhaust Manifold Gaskets, Heavy Duty, each	\$ 29.00
Exhaust Manifold Gaskets, standard, each	\$ 8.00
Valve Cover Gaskets, each	\$ 10.00

For monthly specials, please visit our website: [www.wilsonsbird.com](http://www.wilsonsbird.com)



# Mechanical Parts

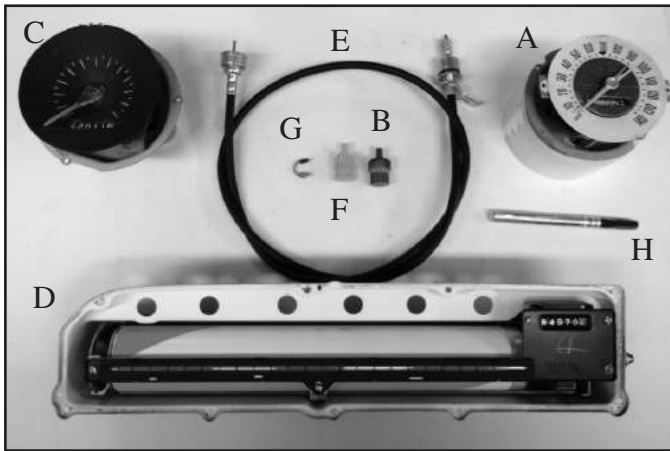

## Speedometers and Related Parts

- |   |          |
|---|----------|
| A. 1958-1960 Speedometer, used & tested       | \$ 75.00 |
| B. 1958-1963 Speedometer Gear, 18 tooth       | \$ 20.00 |
| C. 1961-1963 Speedometer, used & tested       | \$ 75.00 |
| D. 1964-1966 Speedometer, used & tested       | \$ 85.00 |
| 1958-1960 Speedometer Cable                   | \$ 39.95 |
| 1961-1963 Speedometer Cable                   | \$ 39.95 |
| E. 1964-1965 Cable, without Cruise Control    | \$ 39.95 |
| 1965-1966 Cable, upper, with Cruise Control   | \$ 39.95 |
| 1965-1966 Cable, lower, with Cruise Control   | \$ 39.95 |
| 1966 Cable, without Cruise Control            | \$ 39.95 |
| F. 1964-1966 Speedometer Gear, 16 to 20 tooth | \$ 20.00 |
| G. 1958-1966 Speedometer Gear Retaining Clip  | \$ 2.00  |
| H. 1964-1966 Speedometer Number Paint Pen     | \$ 6.00  |

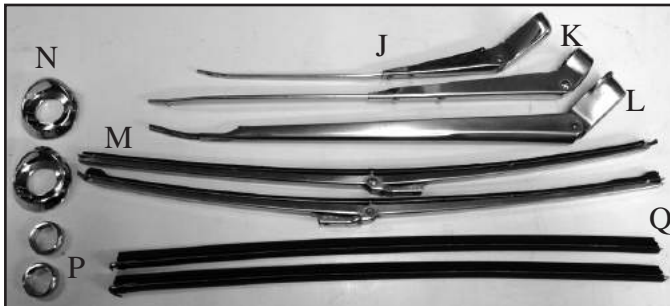

## Windshield Wiper Parts

- |  |          |
|--|----------|
| J. 1958-1960 Wiper Arms, Replacement, pair   | COMING   |
| K. 1961-1963 Wiper Arms, Replacement, pair   | SOON     |
| L. 1964-1965 Wiper Arms, Replacement, pair   | \$ 49.95 |
| M. 1958-1966 Wiper Blades, used              | CALL     |
| N. 1964-1965 Wiper Pivot Bezel, each         | \$ 15.00 |
| P. 1964-1965 Wiper Pivot Bezel Nut, each     | \$ 7.50  |
| Q. 1958-1966 Wiper Refills, pair             | \$ 12.00 |
| R. 1958-1960 Wiper Vacuum Lines, 4 piece set | \$ 30.00 |
| 1958-1966 Wiper Motors                       | CALL     |
| 1958-1966 Wiper Linkages and Arms, used      | CALL     |



## Harmonic Balancer

S. 1960-1964 New

\$ 99.95

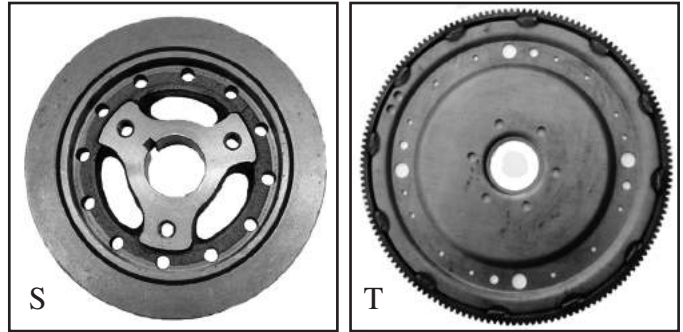

## Flywheels with Ring Gear

- |                                       |          |
|---------------------------------------|----------|
| 1958-1964 Flywheel, 153-Tooth, new    | \$120.00 |
| T. 1965-1966 Flywheel, 184-Tooth, new | \$120.00 |
| 1958-1966 Flywheel, used              | \$ 60.00 |
| 1966 Flywheel, w/428, weighted, new   | \$130.00 |

## Generators and Alternators

- |                                 |          |
|---------------------------------|----------|
| U. 1958-1960 Rebuilt Generator  | \$145.00 |
| 1961-1962 Rebuilt Generator     | \$145.00 |
| 1963-1964 Rebuilt Alternator    | \$ 95.00 |
| V. 1965-1966 Rebuilt Alternator | \$ 99.00 |
| 1958-1962 Core Charge           | \$ 50.00 |
| 1963-1964 Core Charge           | \$ 75.00 |
| 1965-1966 Core Charge           | \$ 50.00 |

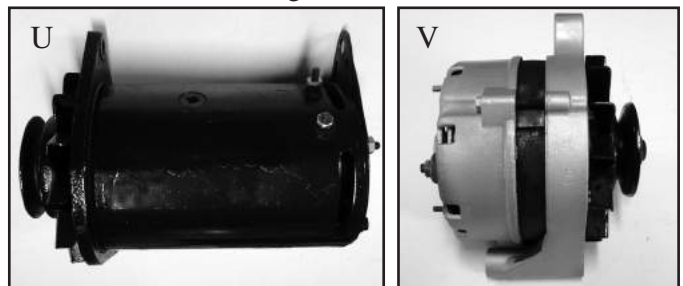

## Temperature Sending Units

- |              |         |
|--------------|---------|
| W. 1958-1963 | \$16.50 |
| X. 1964      | \$16.50 |
| Y. 1965-1966 | \$16.50 |

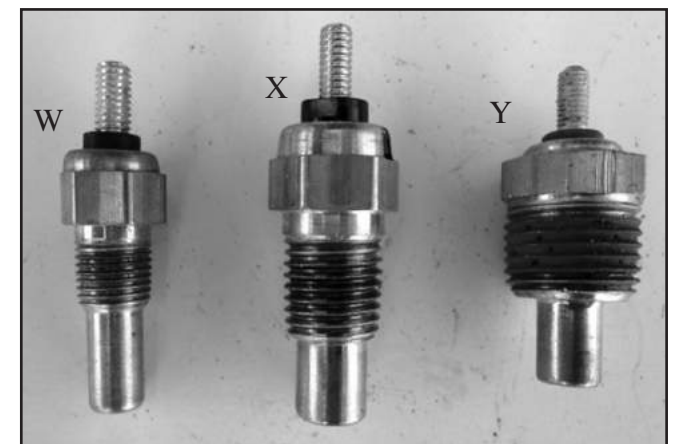

## Fan Belts

### 1958-1960 352 c.i. Engine

Fan and Generator, with AC	\$13.95
Fan and Generator, without AC	\$13.95
Power Steering, all	\$13.95
AC Compressor	\$14.95

### 1958-1960 430 c.i. Engine

Fan and Generator, all	\$13.95
Power Steering, without AC	\$16.95
AC Compressor	\$15.95

### 1961-1962

Fan and Generator, with AC, 2 required	\$13.95
Fan and Generator, without AC	\$13.95
Power Steering, with AC	\$16.95
Power Steering, without AC	\$15.95
AC Compressor	\$16.95
Belt Guard (shown below)	\$14.00



### 1963

Fan and Alternator, with AC, 2 required	\$13.95
Fan and Alternator, without AC	\$13.95
Power Steering, with AC	\$16.95
Power Steering, without AC	\$15.95
A/C Compressor	\$16.95

### 1964

Fan and Alternator, with AC	\$13.95
Fan and Alternator, without AC	\$13.95
Power Steering, with AC	\$13.95
Power Steering, without AC	\$15.95
A/C Compressor	\$17.95

### 1965

Fan and Alternator, with AC	\$13.95
Fan and Alternator, without AC	\$13.95
Power Steering, with AC	\$14.95
Power Steering, without AC	\$15.95
A/C Compressor	\$17.95

### 1966 390 c.i. or 428 c.i. Engine

Fan and Alternator, without AC, without Air Pump	\$13.95
Fan and Alternator, without AC, with Air Pump	\$13.95
Fan and Alternator, with AC	\$13.95
Power Steering, with AC	\$14.95
Power Steering, without AC	\$15.95
Air Pump (California Emissions), without AC	\$14.95
AC Compressor	\$17.95
AC Compressor and Air Pump	\$22.95

## Air Conditioning Parts

### Perfect Fit AC Systems

- \* All Interior Components
- \* Condenser And Hose Assemblies
  - \* Sanden Style Compressor
  - \* Engine Mounting Brackets
- \* Complete detailed installation instructions



\$1399.00

"Perfect Fit Systems" have an excellent reputation for uncompromised quality, and their component selection and attention to detail is evident in all aspects of the product line! Every component was chosen for superior design and quality rather than low cost.

For monthly specials, please visit our website: [www.wilsontbird.com](http://www.wilsontbird.com)

# Air Conditioning Parts

## AC Compressors and Parts

- |  |          |
|--|----------|
| A. 1961-1964 Replacement Compressor, rebuilt | \$259.00 |
| 1965-1966 Original Compressor, rebuilt       | \$259.00 |
| B. 1961-1966 Rebuilt AC Compressor Clutch    | \$115.00 |
| Core Charge on Above Parts                   | \$100.00 |
| 1958-1961 Compressor Service Valve           | \$ 35.00 |
| 1961-1966 Compressor Service Valve           | \$ 35.00 |
| 1958-1966 Compressor Service Valve Caps, pr. | \$ 12.00 |
| C. 1958-1960 AC Clutch Brushes               | \$ 49.95 |
| D. 1961-1966 AC Clutch Brushes               | \$ 49.95 |
| E. 1958-1963 Tecumseh Compressor Rebuild Kit | \$ 59.95 |
| F. 1963-1966 York Compressor Rebuild Kit     | \$ 59.95 |
| G. 1958-1966 AC Compressor Crank Seal Kit    | \$ 45.00 |
| H. 1961-1966 AC Vacuum Motor, used & tested  | \$ 45.00 |
| 1961-1963 AC Vacuum Hose Kit                 | \$ 20.00 |
| 1964-1966 AC Vacuum Hose Kit                 | \$ 35.00 |
| J. 1958-1960 AC Box to Register Plenum Kit   | \$ 80.00 |
| K. 1964-1966 AC Box to Register Plenum, used | \$ 50.00 |
| L. 1961-1965 AC Vacuum Storage Tank, new     | \$ 49.95 |
| M. 1966 AC Vacuum Storage Tank, new          | \$ 49.95 |
| N. 1961-1966 AC Expansion Valve              | \$ 61.00 |
| 1958-1960 Compressor Oil, 8 oz. Bottle       | \$ 15.00 |
| 1958-1966 Used AC and Heater Controllers     | CALL     |

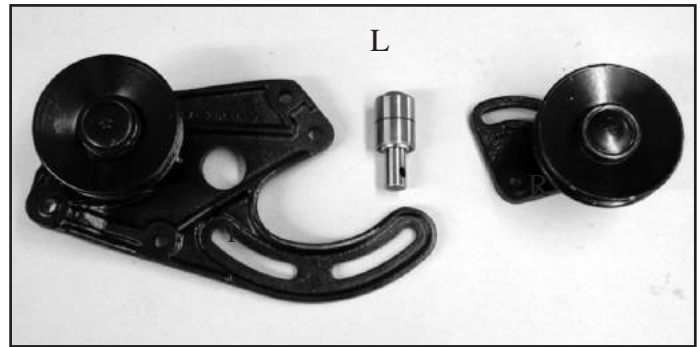

## AC Idler Pulley Assemblies

- |  |         |
|--|---------|
| P. 1961-1966 Adjuster Pulley Assembly, new   | \$69.95 |
| 1961-1966 Idler Pulley Bearing, new          | \$85.00 |
| 1965-1966 PS Pump Bracket w/ Pulley, rebuilt | \$75.00 |
| 1964-1966 Core Charge                        | \$80.00 |

## Defroster Ducts and Hoses

- |   |          |
|---|----------|
| R. 1958-1966 Defroster Hoses, pair, new | \$ 16.00 |
| S. 1959-1960 Defroster Ducts, pair, new | \$ 89.95 |
| 1961-1963 Defroster Ducts, used         | CALL     |
| 1964-1966 Defroster Ducts, used         | CALL     |

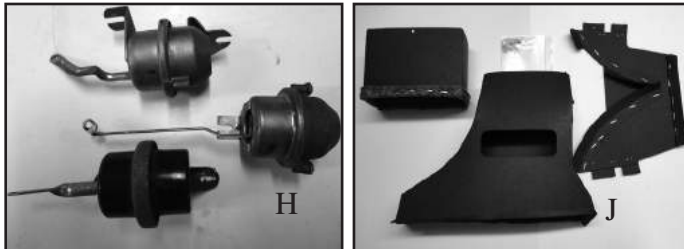
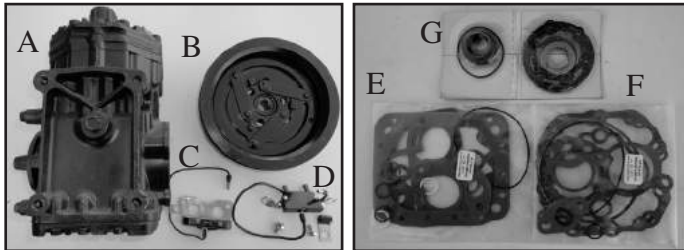

## AC Receiver/Driers

- |                  |          |
|------------------|----------|
| T. 1958-1960 New | \$130.00 |
| U. 1961-1960 New | \$130.00 |
| V. 1964-1966 New | \$130.00 |

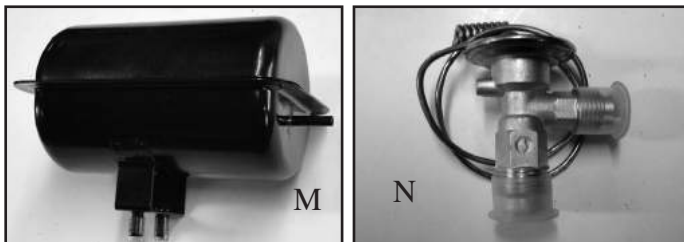
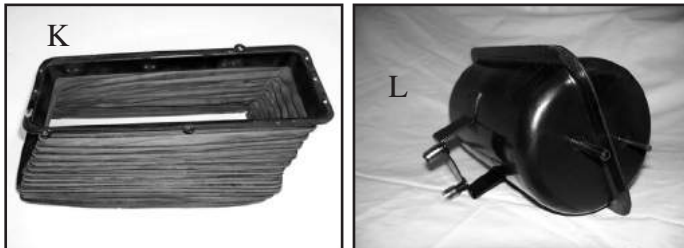



# Brake System Parts

## Brake Drums & Rotors

- 1958-1966 Used Drum or Rotor CALL  
 A. 1958-1960 Drum, Front or Rear, new \$ 99.00  
 1958-1964 Front Drum Hub Grease Seal, each \$ 14.00  
 1961-1962 Front Drum, new \$130.00  
 1963-1966 Rear Drum, new \$135.00  
 1963-1964 Front Drum, new \$120.00  
 B. 1965-1966 Rotors, without Hubs, new \$115.00  
 1965-1966 Front Rotor Hub Grease Seal, each \$ 16.00

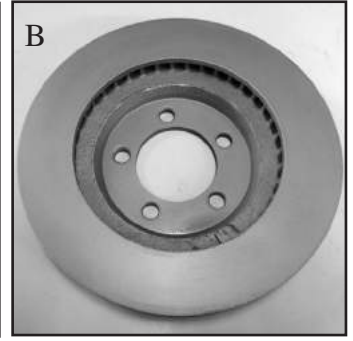
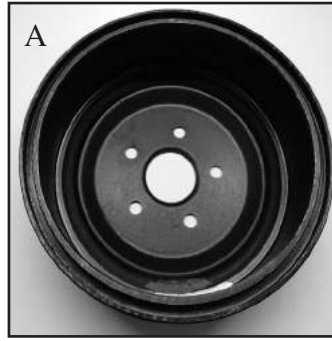

## Master Cylinders & Caps

- C. 1958-1960 Manual or Power \$110.00  
 D. 1961-1964 Drum / Drum \$ 79.50  
 E. 1965-1966 Disc / Drum \$129.50  
 F. 1958-1960 Master Cylinder Cap, Steel \$ 10.00  
 G. 1961-1964 Master Cylinder Cap, Gold Cad \$ 16.00  
 H. 1961-1964 Master Cylinder Cap, Chrome \$ 20.00  
 J. 1965-1966 Master Cylinder Cap, Gold Cad \$ 20.00  
 K. 1965-1966 Master Cylinder Cap, Chrome \$ 22.00  
 1958-1960 Master Cylinder Cap Seal \$ 2.00  
 1961-1964 Master Cylinder Cap Seal \$ 6.95  
 L. 1965-1966 Master Cylinder Cap Seal \$ 9.00

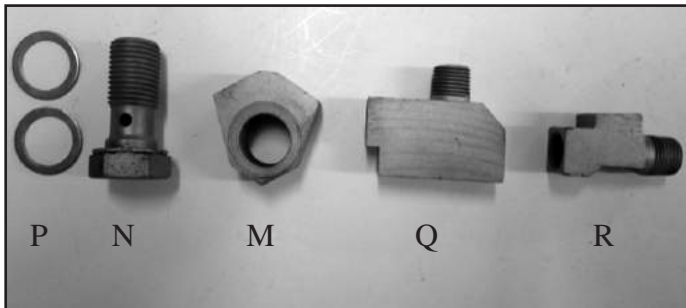

## Master Cylinder Fittings

- M. 1958-1960 Brake Switch Adapter \$ 20.00  
 N. 1958-1960 Adapter Banjo Bolt \$ 9.00  
 P. 1958-1960 Banjo Bolt Copper Washers, each \$ .75  
 Q. 1961-1964 Master Cylinder Junction Block \$ 20.00  
 (Three Outlets)  
 R. 1965-1966 Master Cylinder Junction Block \$ 20.00  
 (Two Outlets)



## Front Brake Lines

	Steel	Stainless
1958 Front Brake Lines	\$80.00	\$125.00
1959-1960 Manual or Power (3 pc.)	\$80.00	\$125.00
1961-1963 Power (3 pc.)	\$80.00	\$125.00
1963-1964 Power (3 pc.)	\$80.00	\$125.00
1965-1966 Power (3 pc.)	\$80.00	\$125.00

## Front to Rear Brake Line

	Steel	Stainless
1958-1960	\$55.00	\$70.00
1961-1963	\$55.00	\$70.00
1964-1966	\$55.00	\$70.00

## Rear Axle Brake Line

	Steel	Stainless
1958-1960 (2 pc.)	\$35.00	\$50.00
1961-1963 (2 pc.)	\$35.00	\$50.00
1964-1966 (2 pc.)	\$35.00	\$50.00

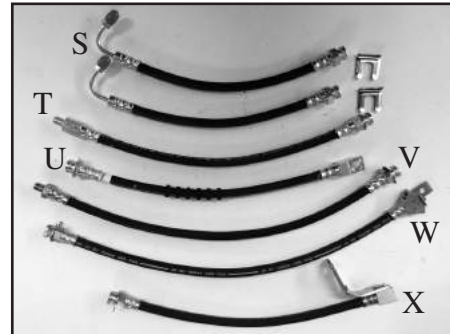

## Brake Hoses

S. 1958 Front Upper	\$30.00
T. 1958-1960 and 1963 Front	\$28.95
1961-1962 and 1964 Front	\$28.95
U. 1965-1966 Front	\$24.00
V. 1958-1960 Rear	\$37.00
1961-1962 Rear	\$37.00
W. 1963 Rear with Brass Bracket as Original	\$49.95
X. 1964-1966 Rear with Brass Bracket as Original	\$49.95

For monthly specials, please visit our website: [www.wilsonsbird.com](http://www.wilsonsbird.com)

# Brake System Parts

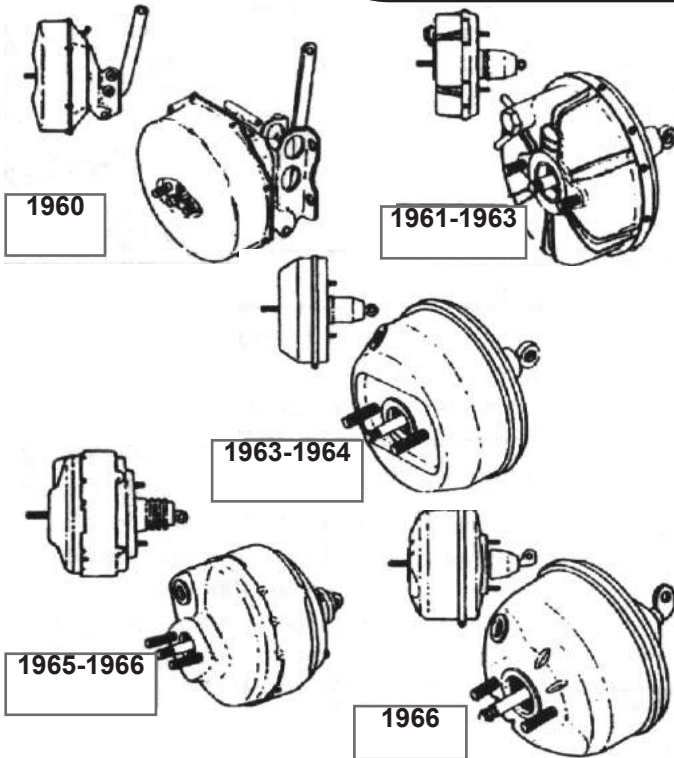

## Power Brake Boosters

1958-1960 Under Dash Kelsey-Hayes Unit, rebuilt	\$215.00
1960 Booster, rebuilt	\$215.00
1961-1962 Booster, rebuilt	\$215.00
1961-1964 Booster <b>NEW</b>	\$170.00
1963-1964 Booster, rebuilt	\$215.00
1965-1966 Booster, rebuilt	\$215.00
1966 Booster, rebuilt	\$215.00
Core Charge on All Rebuilt Boosters	\$150.00

**All boosters are shipped with check valves installed.**



## Brake Booster Parts

1958-1960 Brake Booster Steel Vacuum Line	\$ 12.00
1958-1960 Booster Vacuum Storage Tank, used	\$ 80.00
A. 1961-1963 Master Cylinder Spacer	\$ 19.95
B. 1961-1963 Spacer Attaching Clip	\$ 6.95
C. 1961-1963 Aluminum Check Valve w/ Bolt, as Original, with o-rings	\$ 34.95
1961-1964 Booster Rod Firewall Seal	\$ 12.00
D. 1964-1966 Master Cylinder Spacer, 2 piece	\$ 40.00
E. 1964-1966 Booster Check Valve, with Seal	\$ 19.95

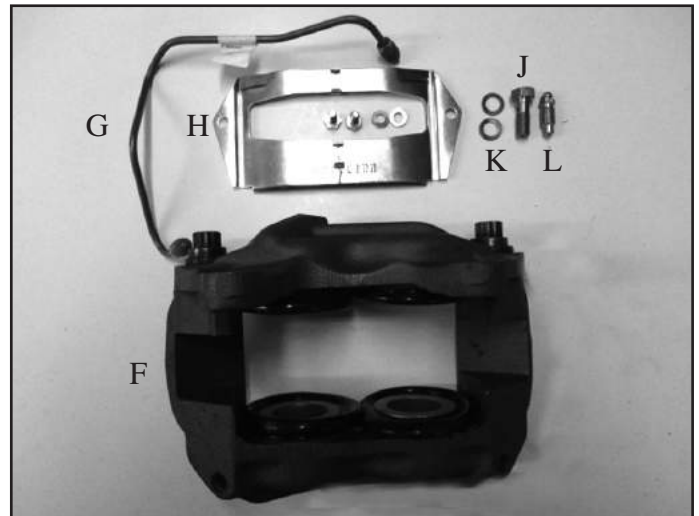

## Brake Calipers

1965-1966 Caliper assembly, new, each	\$165.00
F. 1965-1966 Rebuilt Calipers, Left or Right	\$115.00
Core Charge on all rebuilt Calipers	\$ 75.00
G. Caliper Crossover Lines, Left or Right	\$ 12.00
H. Brake Pad Hold Down Plate, new	\$ 15.00
J. Hose to Caliper Banjo Bolts, each	\$ 9.00
K. Banjo Bolt Copper Washers, each	\$ .75
L. Caliper Bleeder Screws, each	\$ 3.25
M. Caliper Pistons, each	\$ 21.25
N. Caliper Seal Kit (1 kit does 1 caliper)	\$ 24.95

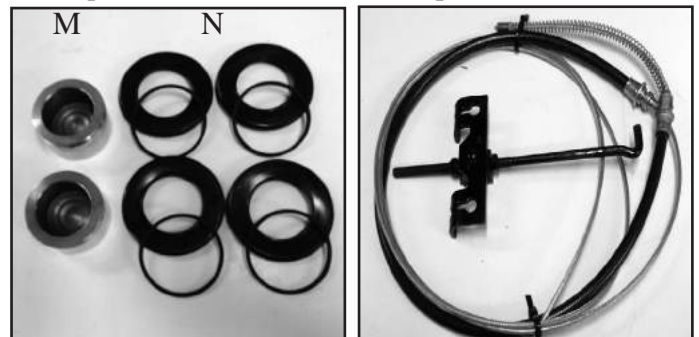

## Parking Brake Parts

1961-1962 Parking Brake Ratchet Assy., used	\$ 75.00
1963 Parking Brake Ratchet Assy., used	CALL
1964-1966 Parking Brake Ratchet Assy., used.	\$ 75.00
1964-1966 Ratchet Vacuum Pull-off Diaphragm	\$ 59.00
(F on next page)	
1958-1960 Front Parking Brake Cable	\$ 35.95
1961-1963 Front Parking Brake Cable	\$ 35.95
1964-1966 Front Parking Brake Cable	\$ 35.95
1958-1959 Rear Parking Brake Cable (2 Req.)	\$ 35.95
1960 Rear Parking Brake Cable (2 Required)	\$ 35.95
1961-1963 Rear Parking Brake Cable (2 Req.)	\$ 35.95
1964-1966 Rear Parking Brake Cable (2 Req.)	\$ 35.95
1958-1966 Cable Equalizer Rod, new	\$ 12.00
1958-1966 Front Cable Adjusting Nut, new	\$ 7.00
1961-1964 Parking Brake Pedal Pad	\$ 6.95
1965-1966 Parking Brake Pedal Pad	\$ 6.95

# Brake System Parts

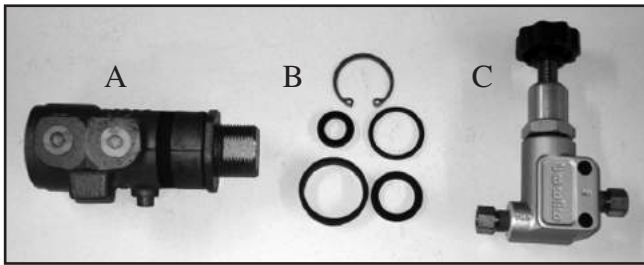

## Proportioning Valves & Parts

- |   |         |
|---|---------|
| A. 1965-1966 Rebuilt Original Valve       | \$55.00 |
| Core Charge on Rebuilt Valve              | \$25.00 |
| B. 1965-1966 Original Valve Rebuild Kit   | \$19.00 |
| C. 1965-1966 Adjustable Replacement Valve | \$65.00 |

## Brake Shoes and Pads

All prices are per axle.

- |                                  |         |
|----------------------------------|---------|
| 1958-1959 Front or Rear Shoes    | \$42.00 |
| 1960 Front or Rear Shoes         | \$42.00 |
| D. 1961-1962 Front or Rear Shoes | \$42.00 |
| 1963-1964 Front or Rear Shoes    | \$42.00 |
| 1965-1966 Rear Shoes             | \$42.00 |
| E. 1965-1966 Front Pads          | \$35.00 |

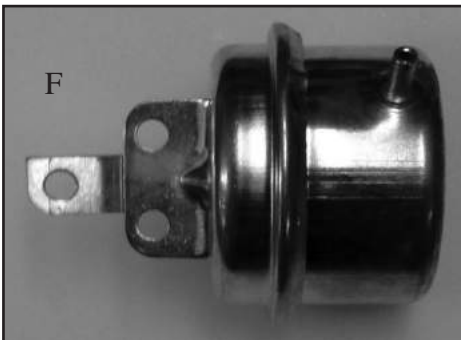
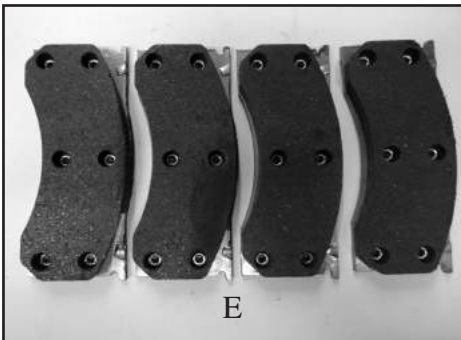
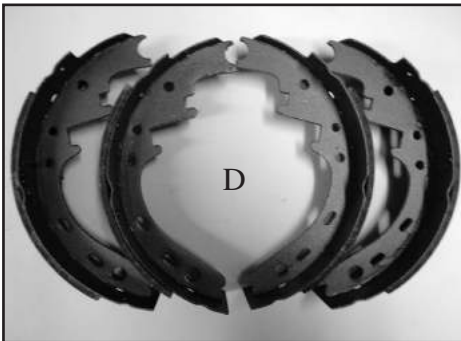

## Wheel Cylinders

- |                    |         |
|--------------------|---------|
| 1958 Front         | \$47.00 |
| G. 1959-1960 Front | \$47.00 |
| 1958-1960 Rear     | \$25.00 |
| 1961-1962 Rear     | \$25.00 |
| 1961-1964 Front    | \$47.00 |
| H. 1963-1966 Rear  | \$25.00 |

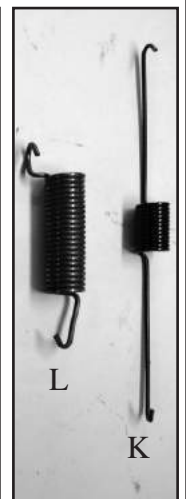
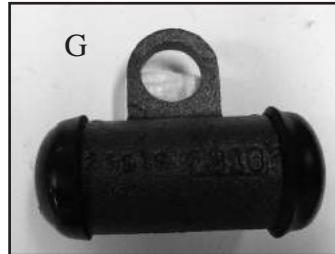

## Drum Brake Hardware

- |  |         |
|--|---------|
| J. 1958-1966 Brake Hardware Kit, per Axle, rear    | \$22.95 |
| K. 1958-1960 Brake Equalizer Spring                | \$ 3.50 |
| L. 1961-1964 Brake Hardware Kit, per Axle, front   | \$29.95 |
| 1961-1966 Self Adjuster Spring                     | \$ 4.95 |
| 1961-1966 Self Adjuster Kit, per Side,             | \$15.95 |
| M. includes one of each: M through Q               |         |
| N. 1961-1966 Self Adjuster Assembly, Right or Left | \$ 8.00 |
| P. 1961-1966 Self Adjuster Cable                   | \$ 6.00 |
| Q. 1961-1966 Self Adjuster Arm, Right or Left      | \$ 3.00 |
| 1961-1966 Self Adjuster Cable Guide                | \$ 3.00 |

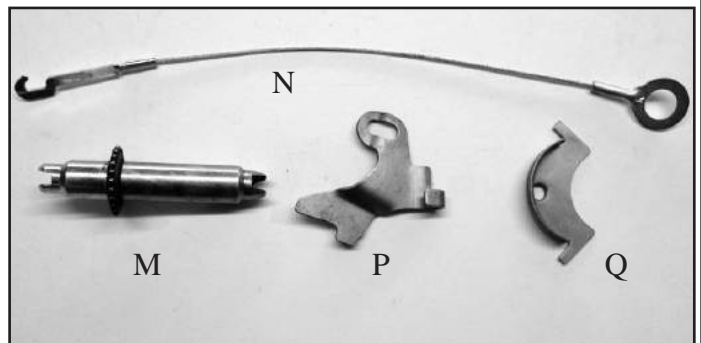



# Fuel System Parts

## Fuel Lines

	Steel	Stainless
1958-1960 Front to Rear Line, 2-piece set	\$75.00	\$104.00
1961-1963 Front to Rear Line, 2-piece set	\$75.00	\$104.00
1964-1966 Front to Rear Line, 2-piece set	\$75.00	\$104.00

## Fuel Pump to Carburetor Line

	Steel	Stainless
1958-1960	\$29.00	\$35.00
1962-1965	\$29.00	\$35.00
1966	\$29.00	\$35.00

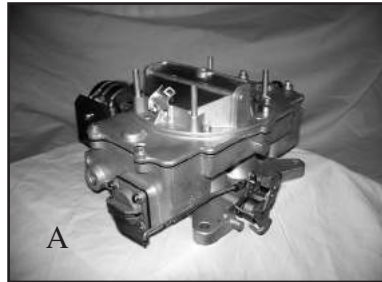
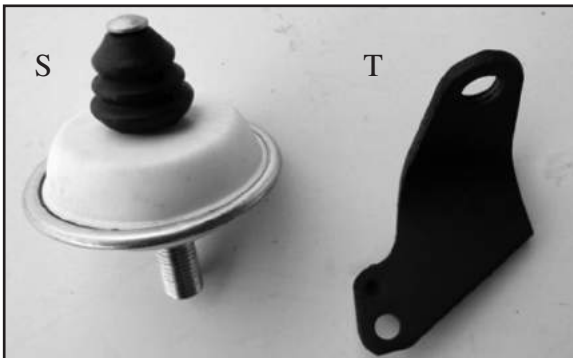
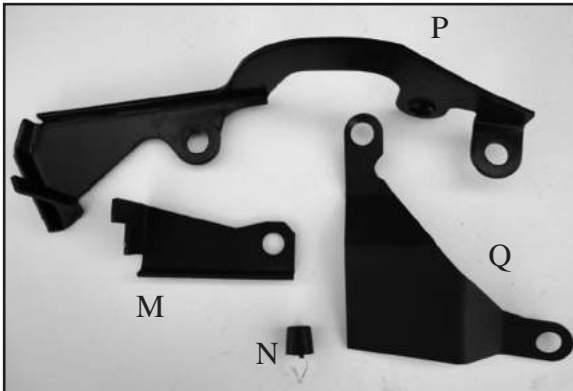
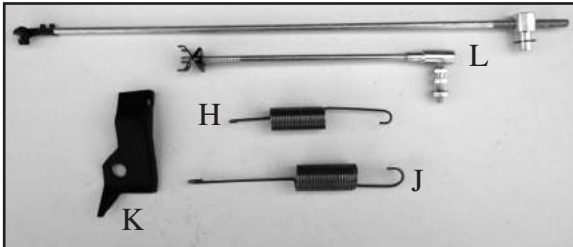
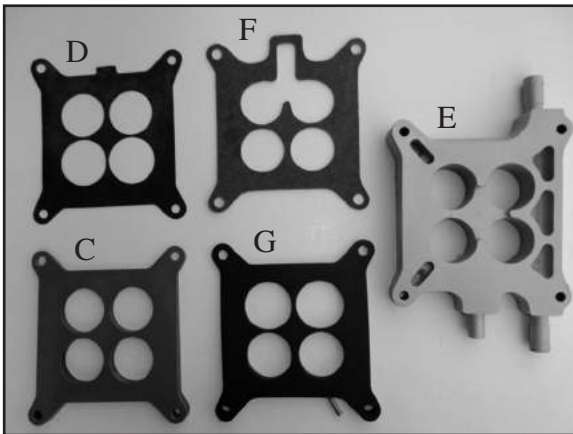

## Carburetors & Related Parts

A. 1958-1966 Rebuilt Original AutoLite Carburetor	\$340.00
Core Charge ( <u>Must</u> be an AutoLite Carburetor)	\$100.00
B. 1958-1966 Holley Replacement, new	\$379.00
<b>No Core Required on New Carburetor</b>	
1958-1966 Rebuild Kit	\$ 55.00
1963-1964 Carburetor Fast Idle Cam	\$ 17.00
1958-1966 Carburetor Fast Idle Cam	\$ 13.00
1958-1966 Carburetor Bowl Float	\$ 19.00
C. 1958-1961 Carburetor Spacer Plate	\$ 60.00
D. 1958-1966 Carburetor Base Gasket	\$ 3.95
E. 1961-1966 Carb. Spacer Plate w/ PCV Outlet, used	\$ 60.00
F. 1961-1965 Carburetor Base Gasket, with Vacuum Port Cut Out	\$ 3.95
G. 1966 Carburetor Spacer Plate with Vacuum Port	\$ 60.00
H. 1961-1966 Kick Down Return Spring	\$ 4.95
J. 1958-1966 Carburetor Return Spring	\$ 4.95
K. 1961-1966 Carburetor Return Spring Clip, Rear of Intake Manifold, new	\$ 20.00
L. 1961-1966 Accelerator & Kick Down Rod Set, new	\$ 29.95
1961-1965 w/ Cruise-O-Matic Kick Down Rod, new	\$ 49.95
1966 w/ C6 Kick Down Rod, new	\$ 49.95
M. 1961-1964 Throttle Stop Bracket	\$ 20.00
N. 1961-1966 Throttle Stop Bumper	\$ 3.50
P. 1965-1966 Cruise-O-Matic Throttle Stop Bracket	\$ 25.00
Q. 1966 C6 Throttle Stop Bracket	\$ 20.00
1958-1960 Gas Pedal Rod Through Firewall Seal	\$ 2.00
1961-1966 Accelerator Linkage Firewall Seal	\$ 5.00
1961-1966 Accelerator Rod End Clips	\$ 3.00
1958-1960 Choke Heat Riser Tube Set	\$ 32.00
R. 1961-1962 Choke Heat Riser Tube Set	\$ 32.00
1963-1964 Choke Heat Riser Tube Set	\$ 32.00
1965-1966 Choke Heat Riser Tube Set	\$ 32.00
S. 1958-1966 Dashpot Assembly	CALL
T. 1958-1966 Dashpot Mounting Bracket	\$ 10.00

# Fuel System Parts

## Fuel Tank Kits

1958-1960	\$325.00
1961	\$350.00
1962-1963	\$350.00
1964-1966	\$375.00



**Kit includes:**

**Fuel tank, fuel tank straps, tank strap mounting hardware, fuel sending unit, and all necessary gaskets and seals.**

## Fuel Tanks

1958-1960	\$235.00
1961	\$235.00
1962-1963	\$235.00
1964-1966	\$235.00

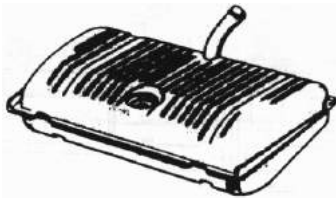

*1958 - 1960 Fuel Tank*

## Fuel Tank Straps

A. 1958-1960	\$ 45.00
B. 1961-1963	\$ 45.00
C. 1964-1966	\$ 45.00



## Fuel Tank Hardware

D. 1958-1960 Strap Bolt Set	\$ 15.00
E. 1961-1963 Strap Bolt Set	\$ 20.00
F. 1964-1966 Strap Bolt Set	\$ 15.00
G. 1961 Fuel Filler Neck	\$ 30.00
H. 1962-1963 Filler Neck	\$ 50.00
J. 1962-1966 Filler Neck O-ring	\$ 2.00
K. 1964-1966 Filler Neck	\$ 80.00
L. 1958-1960 Filler Neck to Body Grommet	\$ 6.95
M. 1961 Fuel Filler Neck Hose, with clamps	\$ 10.00
N. 1964-1966 Filler Neck to Body Seal	\$ 3.95
1958-1960 Gas Cap	\$ 16.00
1961-1966 Gas Cap	\$ 9.00
1958-1966 Locking Gas Cap	\$ 15.00

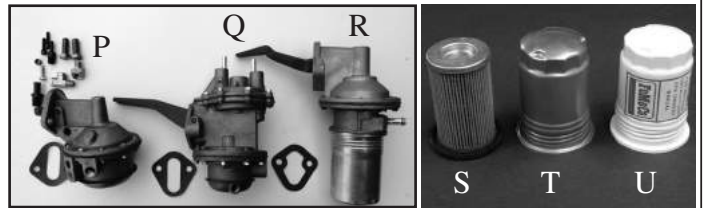
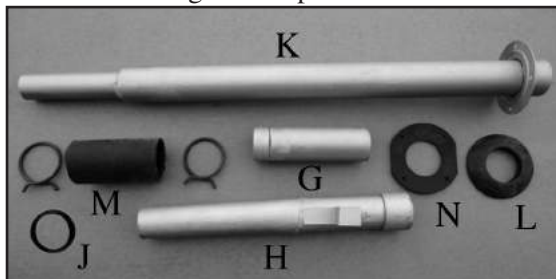

## Fuel Pumps and Parts

P. 1959-1960 with 430 CID	\$120.00
Q. 1958-1960 with Double Action	\$ 95.00
1958-1960 Fuel Pump to Fuel Line Hose	\$ 12.00
1961 Fuel Pump - No Filter Canister	\$ 69.95
R. 1962-1966 Fuel Pump, with Filter Canister	\$ 59.95
1960 Fuel Filter	CALL
S. 1962-1966 Fuel Filter with O-ring	\$ 5.00
T. 1962-1966 Fuel Filter Canister	\$ 16.00
U. 1962-1966 Fuel Filter Canister w/ Ford Script	\$ 18.95

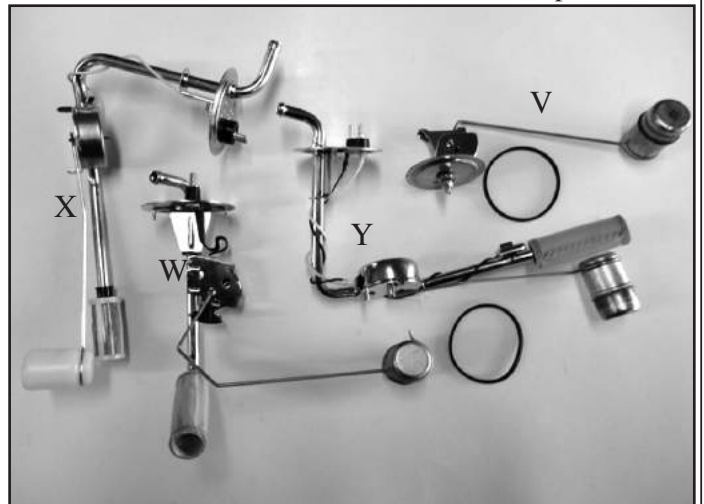

## Fuel Tank Sending Units

V. 1958-1960	\$ 60.00
W. 1961-1963	\$ 75.00
X. 1964-1966 without Low Fuel Light	\$ 85.00
Y. 1964-1966 with Low Fuel Light	\$ 85.00
1964-1966 Low Fuel Light Relay, rebuilt	\$ 35.00

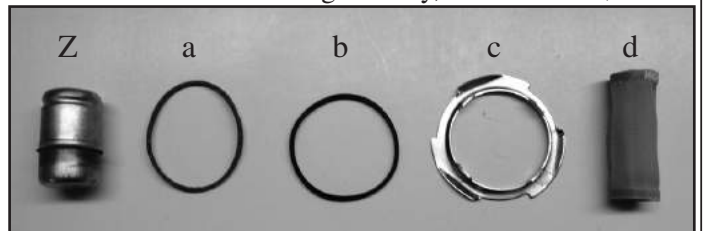

## Fuel Tank Sending Unit Parts

Z. 1958-1966 Fuel Sending Unit Float	\$ 6.00
a. 1958-1960 Fuel Sending Unit O-Ring	\$ 2.00
b. 1961-1966 Fuel Sending Unit O-Ring	\$ 2.00
1958-1960 Sending Unit Lock Ring	\$ 10.00
c. 1961-1966 Sending Unit Lock Ring	\$ 10.00
d. 1961-1966 Sending Unit Sock (Filter)	\$ 8.00

For monthly specials, please visit our website: [www.wilsonsbird.com](http://www.wilsonsbird.com)

# Exhaust Systems and Parts

**All exhaust systems & parts are kept in stock, ready for immediate shipping. Please call for Stainless Steel pricing.**

## 1958-1960

Aluminized Steel

- |  |          |
|--|----------|
| 1. "H" Pipe 352ci                        | \$130.00 |
| 1. "H" Pipe 430ci                        | \$165.00 |
| 2. Intermediate Pipe Left or Right, each | \$ 85.00 |
| 3. Muffler with Down Spout, each         | \$ 65.00 |
| Complete System w/ 352ci                 | \$400.00 |
- Clamps, gaskets, and hangers are not included.

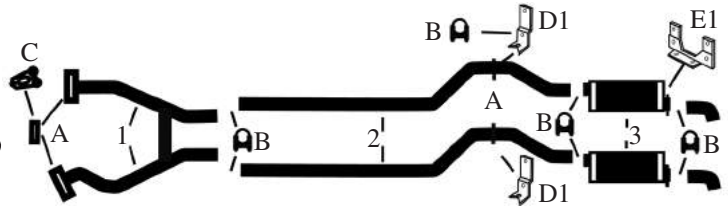

- |                               |         |
|-------------------------------|---------|
| A. Exhaust Gasket, each       | \$ 3.50 |
| B. Exhaust Clamp, each        | \$ 2.50 |
| C. Heat Riser                 | \$80.00 |
| C. Heat Riser Spacer          | \$19.95 |
| D1. Intermediate Hanger, each | \$12.00 |
| E1. Rear Hanger, each         | \$21.00 |

## 1961-1962

### 1963 Dual Exhaust Conversion

Aluminized Steel

- |   |          |
|---|----------|
| 1. "H" Pipe 390ci                                 | \$130.00 |
| 2. Intermediate Pipe with Resonator, L or R, each | \$125.00 |
| 2. Intermediate Pipe w/o Resonator, L or R, each  | \$ 85.00 |
| 3. Muffler with Down Spout, each                  | \$ 65.00 |
| Complete System                                   | \$400.00 |
- Clamps, gaskets, and hangers are not included.

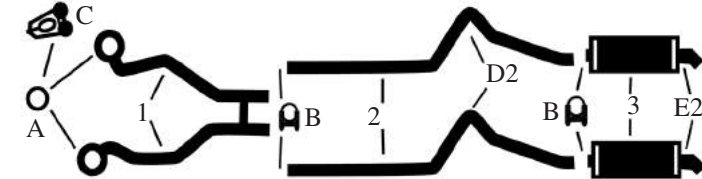

- |  |         |
|--|---------|
| A. Exhaust Gasket, each                          | \$ 3.50 |
| B. Exhaust Clamp, each                           | \$ 2.50 |
| C. 1961 Heat Riser                               | \$80.00 |
| C. 1961 Heat Riser Spacer Plate                  | \$19.95 |
| D2. Intermediate Hangers, Left or Right, each    | \$44.95 |
| E2. Rear Hangers, Left or Right, each <b>NEW</b> | \$44.95 |

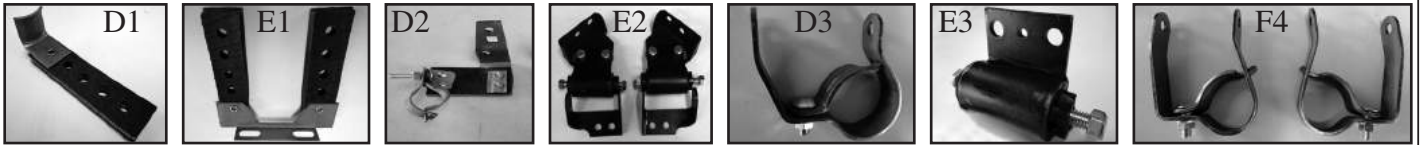

## 1963 Single Exhaust

Aluminized Steel

- |                              |          |
|------------------------------|----------|
| 1. "Y" Pipe 390ci            | \$155.00 |
| 2. Intermediate Pipe         | \$ 90.00 |
| 3. Muffler                   | \$ 75.00 |
| 4. Tail Pipe with Down Spout | \$ 55.00 |
| Complete System              | \$340.00 |
- Clamps, gaskets, and hangers are not included.

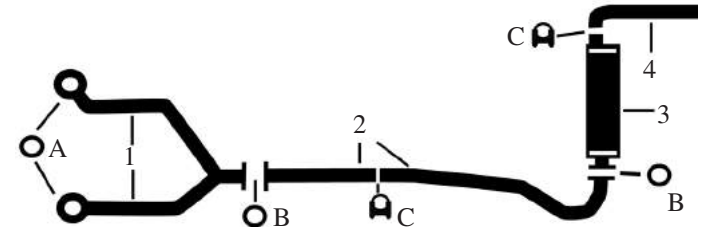

- |                         |         |
|-------------------------|---------|
| A. Exhaust Donut, each  | \$ 6.50 |
| B. Exhaust Gasket, each | \$ 5.00 |
| C. Clamp, each          | \$ 2.50 |
| D3. Rear Hanger         | \$24.95 |
| E3. Rear Hanger Bracket | \$17.00 |

## 1964-1966

Aluminized Steel

- |  |          |
|--|----------|
| 1. "H" Pipe 390-428ci                        | \$135.00 |
| 2. Intermediate Pipe without Resonator, each | \$ 50.00 |
| 2. Intermediate Pipe with Resonator, each    | \$ 90.00 |
| 3. Over the Axle Pipe, Left or Right, each   | \$ 50.00 |
| 4. Muffler with Tailpipe, each               | \$ 60.00 |
| Complete System without Resonators           | \$400.00 |
| Complete System with Resonators              | \$510.00 |
- Clamps, gaskets, and hangers are not included.

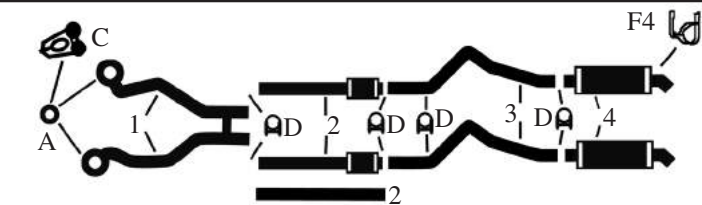

- |                                 |         |
|---------------------------------|---------|
| A. Exhaust Donut, each          | \$ 6.50 |
| B. Exhaust Gasket, each         | \$ 3.50 |
| C. 1966 Heat Riser              | \$89.00 |
| C. 1966 Heat Riser Spacer Plate | \$25.00 |
| D. Clamps, each                 | \$ 2.50 |
| E4. Intermediate Hangers, each  | \$30.00 |
| E3. Rear Hanger Brackets, each  | \$17.00 |
| F4. Rear Hangers, pair          | \$45.00 |

**Check our website for monthly specials, like free exhaust clamps and gaskets with system purchase!**



## Exhaust Systems and Parts

Now Available for all Thunderbirds: Custom / Performance Exhaust Systems!  
 Our standard performance exhaust system is made with 2¼" pipe, and uses "Extreme" performance mufflers, for a very throaty sound and improved engine performance. This system also uses stock hangers for ease of installation. Whether you want a different look to your system, or need a totally radical sound, we can accomodate almost any request. Please call with any questions.

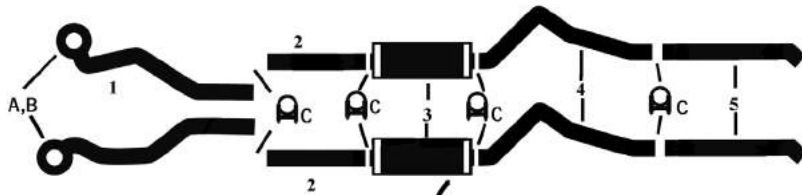

Typical muffler location  
for Extreme mufflers

- |                                   |                 |
|-----------------------------------|-----------------|
| 1. "H" pipe 352, 390, 428 ci      | \$100.00        |
| 2. Intermediate Pipe, each        | \$ 45.00        |
| 3. Muffler "Extreme", each        | \$ 60.00        |
| 4. Over Axle Pipe, each           | \$ 50.00        |
| 5. Tail Pipe, each                | \$ 40.00        |
| <b>Complete System</b>            | <b>\$490.00</b> |
| A. Donut Gasket (1963-1966), each | \$ 6.50         |
| B. Flat Gasket (1958-1960), each  | \$ 3.50         |
| C. 2¼" Exhaust Clamp, each        | \$ 2.00         |

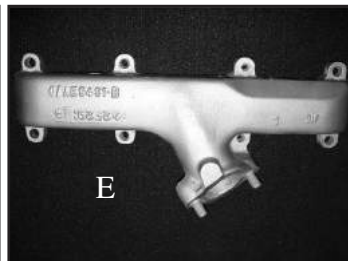

## Exhaust Manifolds and Parts

- |  |          |
|--|----------|
| 1958-1960 w/ 352 ci, Right, Flat Flange, Casting # 575204, new                       | \$275.00 |
| 1959-1960 w/ 430 ci, Right, Flat Flange, Casting # B9EM-9430-A, new                  | \$275.00 |
| A. 1958-1961 Heat Riser, as Original, new  | \$ 80.00 |
| B. 1958-1961 Heat Riser Spacer (no flap), new  | \$ 19.95 |
| 1958-1960 w/ 352 ci, Left, Flat Flange, Casting # 5750730, new                       | \$275.00 |
| 1959-1960 w/ 430 ci, Left, Flat Flange, Casting # B9EL-9431-A, new                   | \$275.00 |
| 1961-1962 Right, Flat Flange, Casting # C1SE-9430-B, new                             | \$275.00 |
| 1961-1962 Left, Flat Flange, Casting # C1SE-9431-B, new                              | \$275.00 |
| 1963-1964 Right, Tapered Flange, Casting # C3SE-9430-B, new                          | \$275.00 |
| 1965 Right, Tapered Flange, Casting # C5SE-9430-C, new                               | \$275.00 |
| 1966 w/390 ci or 428 ci, Right, Flat Flange, Casting # C6AE-9430-A, new              | \$275.00 |
| C. 1966 Heat Riser, as Original, new   | \$ 89.00 |
| D. 1966 Heat Riser Spacer (no flap), new   | \$ 25.00 |
| 1963-1966 w/ 390ci or 428 ci, Left, Tapered Flange, Casting #C3SE-9431-B, new        | \$275.00 |
| E. 1958-1966 Used, Left or Right, Planed with New Studs Installed                    | \$150.00 |
| 1958-1966 Exhaust Manifold Choke Plate, Gasket and Screw                             | \$ 10.00 |
| F. 1958-1966 Exhaust Manifold Gaskets, standard, pair                                | \$ 18.00 |
| G. 1958-1966 Exhaust Manifold Gaskets, "Heavy Duty", w/ 352 ci, 390 ci, 428 ci, each | \$ 29.00 |
| H. 1959-1960 Exhaust Manifold Gaskets, "Heavy Duty", w/ 430 ci, each                 | \$ 29.00 |
| J. 1958-1966 Exhaust Manifold Bolt and Lock Kit, like Original                       | \$ 26.00 |
| 1958-1966 Exhaust Manifold Lock Kit only, like Original                              | \$ 16.50 |
| K. 1958-1966 Exhaust Manifold Studs, w/ Nuts, each                                   | \$ 3.50  |
| 1966 Exhaust Manifold Long Studs, w/ Nuts (for use with Heat Riser or Spacer), each  | \$ 4.50  |

**For monthly specials, please visit our website: [www.wilsonbird.com](http://www.wilsonbird.com)**

# Convertible Parts

## Convertible Tops

The construction of our tops is as close to the original as possible. The vinyl material we use is mildew resistant and will not shrink. All convertible tops include plastic rear window.

1958-1960 Convertible Top, Black or White	\$295.00
1961-1963 Convertible Top, Black or White	\$295.00
1964-1966 Convertible Top, Black or White	\$295.00
1958-1966 Convertible Top Pads	\$ 49.00
1958-1966 Top Frame Tacking Strip Kit	\$ 57.00

## Flip Lid Transmissions and Parts

A. 1960-1963 Flip Lid Transmission Housing	\$210.00
B. 1964-1966 Flip Lid Transmission Housing	\$210.00
C. 1961-1966 Flip Lid Transmission Flat Gear	\$100.00
D. 1961-1966 Flip Lid Transmission Worm Gear	\$100.00
E. 1960-1966 Flip Lid Trans. to Motor Coupler	\$ 19.00

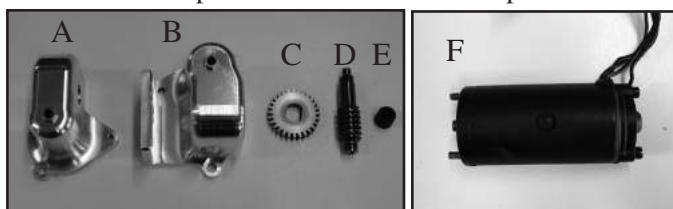

## Flip Lid Motors

1959-1966 New	COMING SOON
F. 1959-1966 Rebuilt	\$125.00
Core Charge on all rebuilt Flip Lid Motors	\$100.00

## Tonneau Covers and Parts

All Tonneau Covers include mounting hardware, instructions, and black, white, or red headrests.

1958-1960 Tonneau Cover	\$799.00
G. 1961-1963 Tonneau Cover	\$799.00
H. 1964-1966 Tonneau Cover	\$899.00
J. 1961-1966 Hold down wing nut and insert	\$ 15.00
K. 1961-1966 Footmans' loop	\$ 10.00
L. 1961-1966 Footmans' loop hold down clamp	\$ 13.95



G. 1961-1963

H. 1964-1966

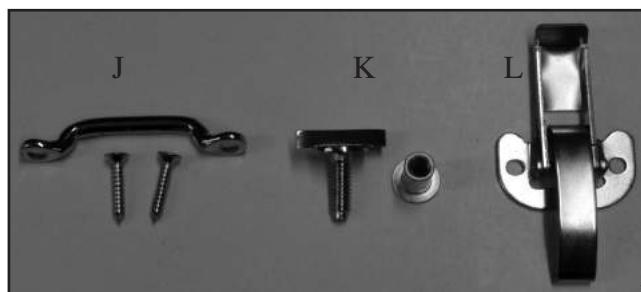

M

## Convertible Top Pumps

M. 1959-1966 Original Style, new	\$269.00
1959-1966 High Volume, new	\$320.00
1959-1966 Used, Cleaned and Tested	\$150.00

## Convertible Top Hose Sets

1958-Early 1959 2 Hose set	\$159.00
Late 1959-1960 5 Hose set	\$289.00
N. 1961-1962 5 Hose set	\$289.00
1962-1963 5 Hose set	\$289.00
1964-1966 5 Hose set	\$289.00



N

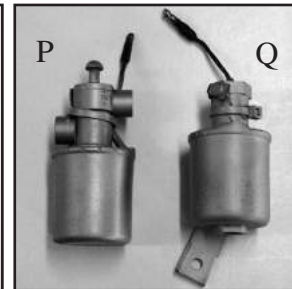

P

Q

## Convertible Top Solenoid Valves

P. 1960-1962 New	\$149.00
1963-1966 New	\$149.00
Q. 1960-1966 Rebuilt	\$75.00
Core Charge on all rebuilt Solenoids	\$50.00

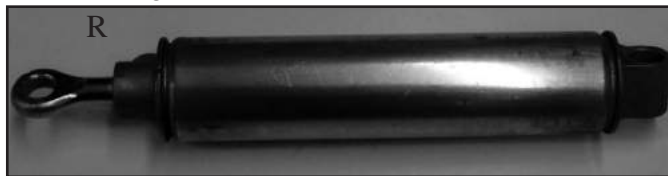

R

## Convertible Top & Trunk Lid Cylinders

R. 1958-1966 New	\$155.00
1958-1966 Used	\$ 75.00



We also offer complete rebuilding services for all flip lid transmission assemblies. From a simple adjustment to a complete overhaul, we can fix it all. Please call for details.

# Convertible Parts

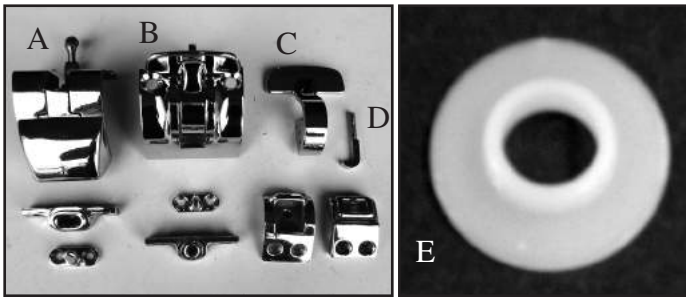

## Convertible Top Frame Parts

- 1958-1960 Conv. Latch Assembly, used CALL
- A. 1961-1963 Conv. Latch Assembly, new, pair \$199.95
- B. 1964-1966 Conv. Latch Assembly, new, each \$ 99.95
- 1964-1966 Conv. Latch Assembly, used CALL
- C. 1964-1966 Latch Handles, new, each \$ 20.00
- D. 1961-1966 "J" hooks, new, each \$ 10.00
- 1958-1966 Latch Line-up Pins and Brackets CALL
- E. 1961-1966 Conv. Trunk Piston Bushing, new \$ 3.50
- 1958-1966 Used Convertible Top Frame Parts CALL
- 1958-1966 Conv. Top Frame Bushings, used CALL

## Convertible Top Control Switches

- 1960 CALL
- F. 1961-1962 New \$ 40.00
- 1963 CALL
- G. 1964-1966 New \$ 70.00
- 1964-1966 Used \$ 40.00



## Convertible Top Limit Switches

- H. 1959-1966 Deck Lock Limit Switch, rebuilt \$140.00
- 1959-1966 Deck Open Limit Switch, rebuilt \$ 85.00
- 1959-1966 Top Down Limit Switch, rebuilt \$110.00
- 1959-1964 Top Up Limit Switch, rebuilt \$ 85.00
- 1965-1966 Top Up Limit Switch, rebuilt \$140.00
- 1959-1963 Tray Erect Limit Switch, rebuilt \$ 85.00
- 1959-1963 Tray Retract Limit Switch, rebuilt \$110.00
- Core Charge on all rebuilt Switches \$ 75.00

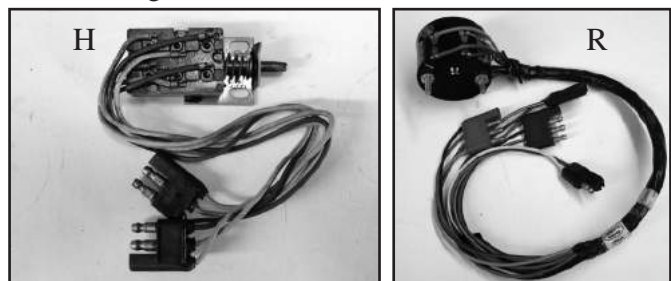

## Convertible Relays

- 1958-1959 Deck Unlock Solenoid Relay \$49.95
- J. 1959-1960 Solenoid Relay, B9SF-15672-A, CALL
- 2 required for 1959-1960
- K. 1960 Additional Solenoid Relay, C0SF-15672-A \$59.95
- 1 required for 1960 12-Relay Setup
- L. 1960 Additional Solenoid Relay, C0SF-15672-C \$59.95
- 1 required for 1960 12-Relay Setup
- M. 1959-1966 Neutral Safety Relay \$49.95
- N. 1959-1963 Action Relay, C0SF-15672-D, new \$49.95
- 8 Required for 1959-1960
- 2 Required for 1961-1963
- P. 1961-1966 Action Relay, C1SF-15672-A, new \$49.95
- 6 Required for 1961-1963
- 4 Required for 1964-1966
- Q. 1964-1966 Action Relay, C2VB-15672-A, new \$49.95
- 4 Required for 1964-1966
- 1958-1966 Relays, used and tested \$30.00
- 1959-1966 Relay Plug Replacement, new \$14.95

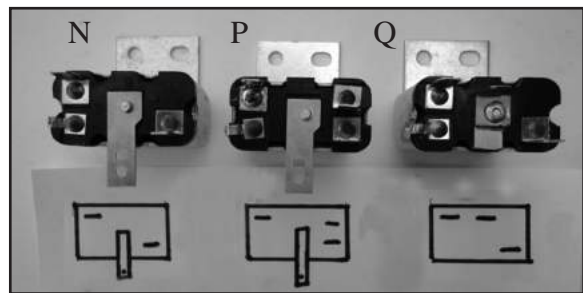
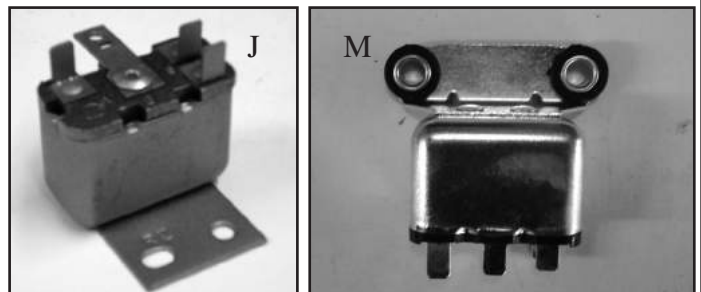
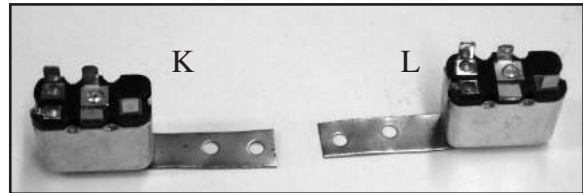

## Convertible Top Circuit Breakers

- 1961-1962 Underhood 60 amp \$ 49.95
- 1963-1966 Underhood 50 amp \$ 49.95
- 1960-1966 In Trunk 15, 20, 30 amp \$ 13.95

## Upper Back Panel Limit Switch

- Better Than Original! Steel Insert will not round out.**
- R. 1964-1966 Rebuilt Switch \$375.00
- Core Charge on Rebuilt Switch \$175.00

For monthly specials, please visit our website: [www.wilsonsbird.com](http://www.wilsonsbird.com)



# Electrical Parts

## Tune Up Parts

- A. 1958-1966 Tune up Kit (distributor cap, points, condenser, 8 spark plugs, and plug wire set) \$85.00
- 1958-1966 Cap Set (distributor cap, points, condenser, and rotor) \$24.95
- 1958-1966 Spark Plug Wire Set, like original \$45.00
- 1958-1966 Spark Plug, Autolite \$ 3.50
- 1958-1966 Spark Plug Wire Separators, clip-on \$ 3.50
- 1958-1966 Plug Wire Separators, floating \$ 2.50

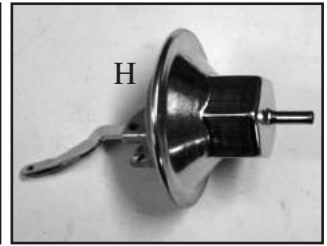
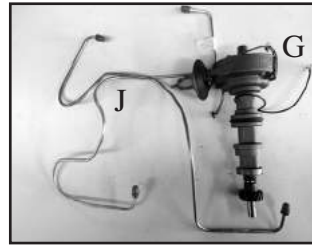

## Distributors and Parts

- G. 1958-1966 Rebuilt Distributor \$99.95  
Core Charge on all rebuilt Distributors \$50.00
- H. 1960-1964 Vacuum Advance, Replacement \$29.00  
1965-1966 Vacuum Advance, Replacement \$29.00
- J. 1958-1966 Vacuum Advance Steel Line \$20.00

## Battery Cable Sets, FoMoCo Script

- 1958 \$60.00
- 1959-1960 \$60.00
- 1961 \$60.00
- 1962-1963 \$60.00
- 1964-1965 \$60.00
- K. 1966 Universal Battery Disconnect Switch \$10.00



## "The Ignitor" by Pertronix

Never change points again. Solid state technology.

- B. 1958-1973 Ford and Thunderbird \$ 79.00  
1958-1973 High performance coil:
- C. 40,000 volts chrome coil \$ 40.00
- D. 40,000 volts black coil \$ 35.00



## Ignition Coils and Mounting Brackets

- E. Mustard Top Coil \$ 39.00
- F. Chrome Coil Mounting Bracket, new \$ 16.00  
Coil Mounting Brackets, used CALL



## Voltage Regulators

- L. 1958-1962 Mechanical Regulator \$49.95
- M. 1963-1966 Electronic Regulator \$24.95
- N. 1963-1966 Regulator Plug Repair Harness \$12.00

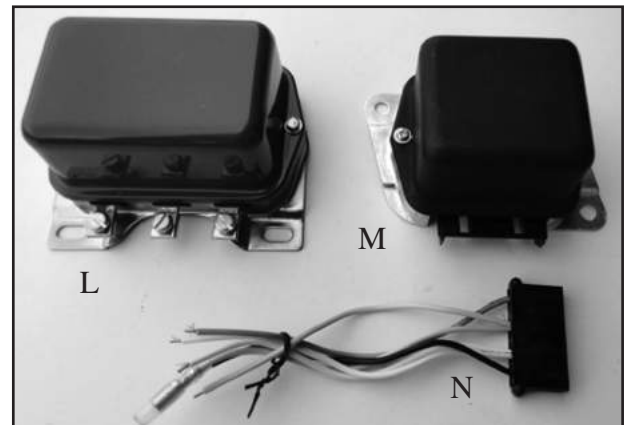

# Electrical Parts

## Starter Relays (Solenoids)

A. 1958-1966 Replacement Style \$ 17.50

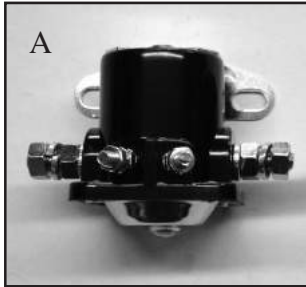

## Constant Voltage Regulator

1958-1960 CALL  
 B. 1961-1966 \$29.00  
 1961-1966 Electronic Replacement \$42.00

## Horns and Horn Parts

C. 1958-1964 Snail Horn, like Original, each \$39.95  
 D. 1965-1966 Snail Horn, Replacements, each \$35.00  
 1958-1966 Horn Mounting Brackets, used CALL  
 E. 1958-1959 Horn Relay, new \$29.00  
 F. 1959-1964 Horn Relay, new \$29.00  
 1966 Horn Relay, with Cruise Control, used \$15.00  
 G. 1961-1964 Horn Contact Spring for Switch \$10.00

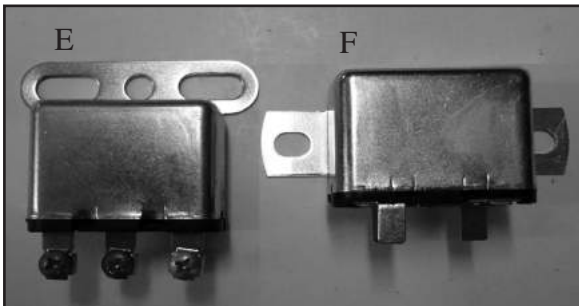
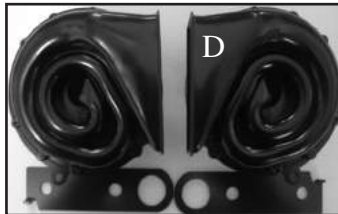
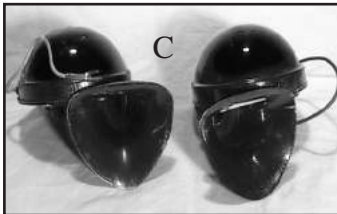

## Stop Light Switches

H. 1958-1964 \$10.00  
 J. 1960-1964 Switch Lead with Plug \$20.00  
 K. 1965-1966 \$40.00

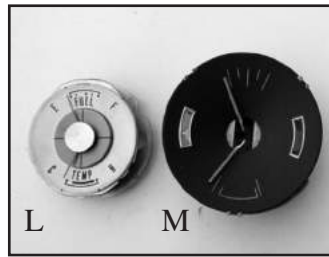
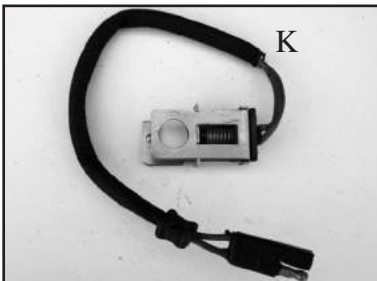
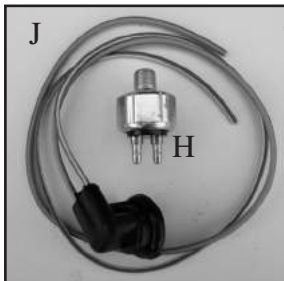

## Dash Gauges (Used)

L. 1958-1960 Fuel / Temperature Gauge CALL  
 M. 1961-1963 Fuel / Temperature Gauge CALL  
 P. 1964-1966 Fuel, Temperature, or Oil Gauge \$45.00  
 1964-1965 Amp Gauge \$75.00  
 1966 Amp Gauge \$75.00  
 1964-1966 Speedo Number Paint Pen \$ 6.00

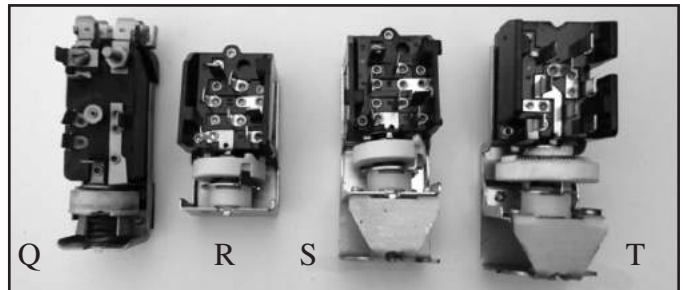

## Headlight Switches

Q. 1958-1960 New \$ 59.95  
 R. 1961-1963 New \$ 39.95  
 S. 1964 New \$ 69.95  
 T. 1965-1966 New \$ 59.00  
 U. 1958-1960 Headlight Dimmer Switch \$ 32.00  
 V. 1961-1966 Headlight Dimmer Switch \$ 10.50

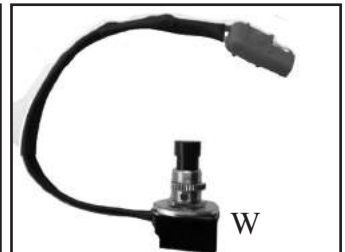
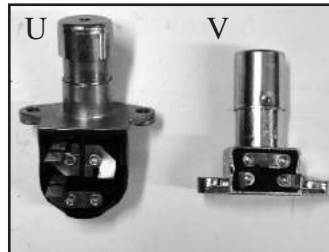

## Emergency (4-Way) Flashers

1964-1966 Flasher Switch, used \$25.00  
 1964-1966 Flasher Assembly \$ 5.00  
 W. 1966 Landau Flasher Switch Replacement \$39.95  
 X. 1966 Landau 3-Wire Relay for Rear Lights \$59.95  
 Y. 1966 Landau 4-Wire Relay for Front Lights \$59.95



For monthly specials, please visit our website: [www.wilsonbird.com](http://www.wilsonbird.com)

# Electrical Parts

## Brake Light Relay

- |  |         |
|--|---------|
| A. 1964 Brake Light Relay Kit, Includes:<br>Relay, Mounting Bracket & Wiring | \$99.95 |
| B. 1963-1964 Relay   | \$49.95 |
| C. 1965-1966 Relay   | \$65.00 |
| D. 1966-1967 Relay   | \$65.00 |

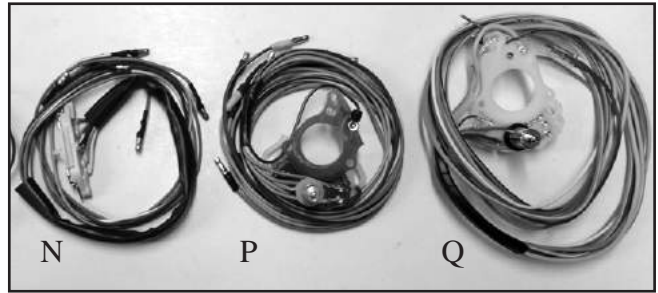
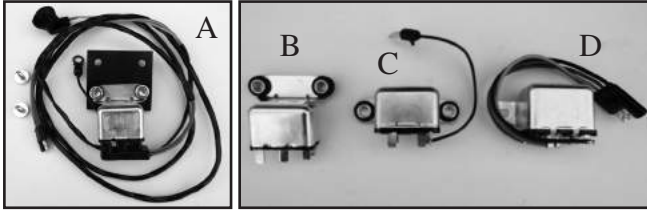

## Turn Signal Switches

- |  |          |
|--|----------|
| M. 1958-1960                             | \$ 99.95 |
| N. 1961-1963 New                         | \$ 59.95 |
| P. 1964 New                              | \$125.00 |
| Q. 1965-1966 without Cruise Control, new | \$ 99.95 |
| 1966 with Cruise Control, used           | \$150.00 |
| 1958-1966 Turn Signal Flasher            | \$ 5.00  |
| 1965-1966 Turn Indicator Relay, rebuilt  | \$ 35.00 |

## Neutral Safety Switch

- |   |         |
|---|---------|
| E. 1958-1960 New                              | \$45.00 |
| 1961-1962 New                                 | \$49.95 |
| F. 1963 New                                   | \$40.00 |
| 1964-1966 w/ Cruise-O-Matic Transmission, new | \$59.95 |
| 1966 w/ C6 Transmission, new                  | \$69.00 |

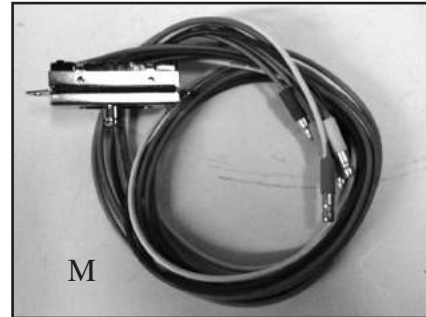
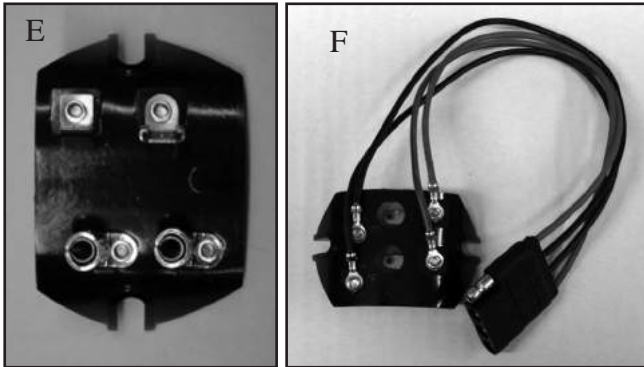

## Electronic Sequential System

This unit replaces the taped-up pack in the trunk which contains the turn signal relay, brake light relay, and sequential motor. This unit does not replace Landau 4-way flasher relays. Also available is a similar unit that can convert 1960 & 1964 tail lights to sequential lights.

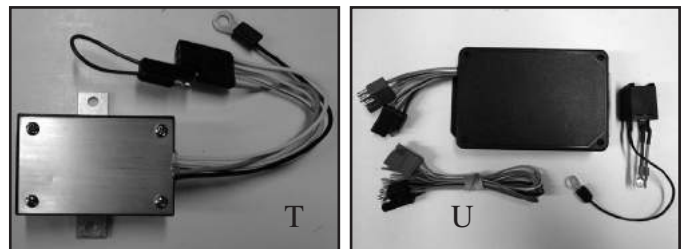
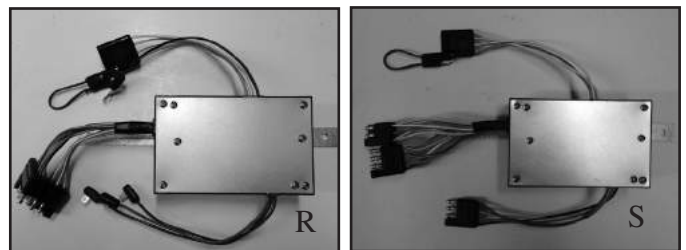

- |  |          |
|--|----------|
| R. 1965-1966 Built Through 11/16/65            | \$209.95 |
| S. 1966 Built From 11/17/65                    | \$209.95 |
| T. 1965-1966 Electronic Seq. Motor Replacement | \$104.95 |
| U. 1960 and 1964 Sequential Conversion Unit    | \$160.00 |

## Clocks

- |                             |          |
|-----------------------------|----------|
| G. 1958 Rebuilt             | CALL     |
| H. 1959-1960 Rebuilt        | CALL     |
| J. 1961-1963 Rebuilt        | CALL     |
| 1964-1965 Quartz Conversion | \$135.00 |
| 1965-1966 Quartz Conversion | \$135.00 |
| K. 1964-1965 Rebuilt        | \$ 99.00 |
| L. 1965-1966 Rebuilt        | \$ 99.00 |
| Core Charge on all Clocks   | \$ 50.00 |

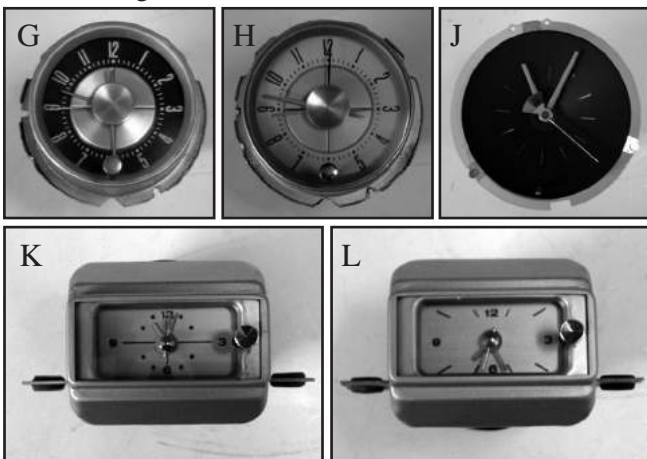



# Electrical Parts

## Window Switches

A. 1958 Switch w/ Black Button	\$35.00
B. 1959-1960 Switch w/ White Button	\$35.00
C. 1961-1962 Door Switch, Chrome Button	\$35.00
1961-1962 Lockout Switch, Chrome Button	\$40.00
D. 1963 Rear Quarter Window, Chrome Button	\$37.50
1963 Console Switch, 3-wire	\$37.50
E. 1963 Console Switch, 2-wire	\$37.50
1964-1966 Console Switch, 3-wire	\$37.50
1964-1966 Console Switch, 2-wire	\$37.50
F. 1964-1966 Rear Quarter Window Switch	\$37.00
G. 1964-1966 Lockout Switch	\$40.00
H. 1958-1960 Switch Power Bar	\$ 3.00
1961-1962 Switch Power Bar	\$ 4.00
J. 1963-1966 Switch Power Bar	\$ 3.50
K. 1958-1966 Window Switch Clip	\$ 2.95
L. 1958-1963 Window Switch Clip	\$ 2.95
M. 1964-1966 Window Switch Clip	\$ 2.95

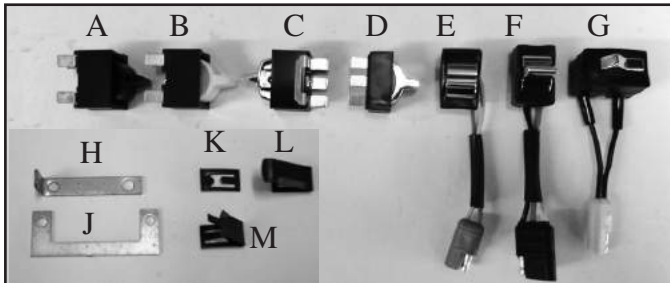

## Window Switch Bezels

N. 1958-1960 Console Bezel, 4-switch	\$25.00
P. 1961-1962 Left Door Bezel, 5-switch	\$50.00
Q. 1961-1962 Right Door Switch Bezel	\$21.00
1961-1962 Rear Quarter Switch Bezel	\$21.00
R. 1961-1963 Switch Bezel Ring	\$10.00
S. 1963 Console Bezel, 2-switch, 2 required	\$18.00
1963 Rear Quarter Switch Bezel	\$18.00
T. 1964-1966 Console Bezel, 5-switch	\$40.00
U. 1964-1966 Rear Quarter Switch Bezel	\$18.00
V. 1964-1966 Switch Plate Decal, 5-switch	\$15.00
W. 1965-1966 Switch Plate Decal, 7-switch	\$15.00
X. 1966 Landau Lockout Hole Cover	\$13.00
Y. 1966 Landau Lockout Switch Placeholder	\$ 2.00
Z. 1966 Landau Switch Plate Decal, 4-switch	\$15.00

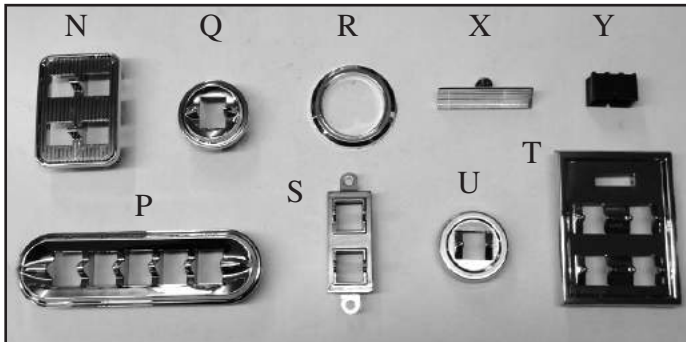

## Window Switch Assemblies

1958 Black Switches	\$200.00
1959-1960 White Switches	\$200.00
1961-1962 Chrome Switches	\$265.00
1963 Chrome Switches, 2 required	\$ 99.95
a. 1964-1966 5 Switch Assembly	\$249.95
b. 1965-1966 7 Switch Assembly	\$300.00
c. 1966 Landau 4 Switch Assembly	\$239.95

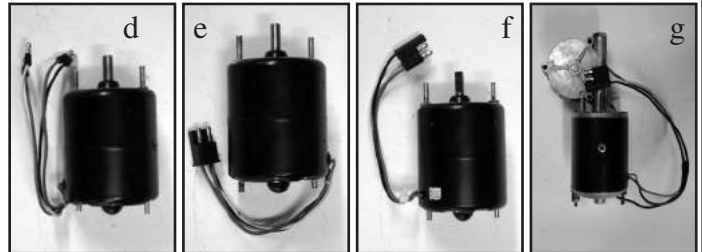

## Power Window Motors

d. 1958-1960 Front or Rear, new	\$175.00
e. 1961-1962 Front, new	\$175.00
f. 1963-1964 Front, new	\$175.00
1964-1966 Rear, new	\$175.00
g. 1965-1966 Front, new	\$175.00
1958-1960 Front or Rear, rebuilt	\$110.00
1958-1960 Rebuilts are by Exchange Only	
1961-1962 Front or Rear, rebuilt	\$110.00
1963-1964 Front or Rear, rebuilt	\$110.00
1965-1966 Front or Rear, rebuilt	\$110.00
1965-1966 Vent Window, rebuilt	\$115.00
1961-1966 Core Charge on all rebuilt Motors	\$ 50.00

**There are no core charges on new motors.**

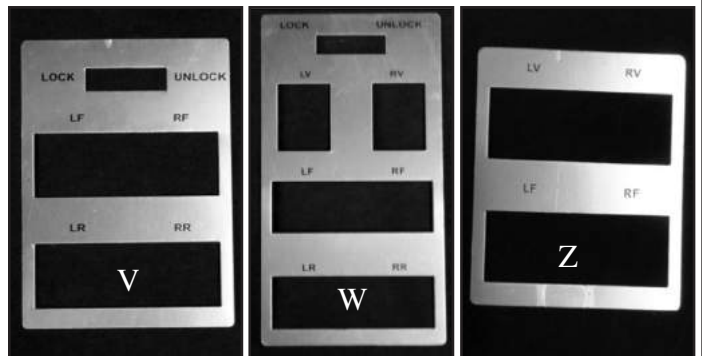

For monthly specials, please visit our website: [www.wilsonbird.com](http://www.wilsonbird.com)

# Electrical Parts

## Power Window Relay

- |                               |         |
|-------------------------------|---------|
| A. 1958-1960 Rebuilt          | CALL    |
| B. 1958-1960 Circuit Breakers | \$13.95 |
| C. 1961-1966 New              | \$59.95 |

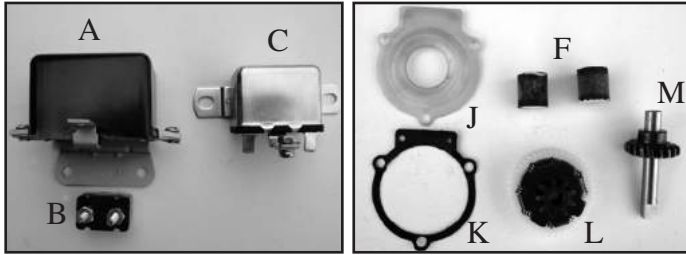

## Window Motor Transmissions and Parts

- |  |         |
|--|---------|
| D. 1958 Window Motor Trans., L or R, used      | \$80.00 |
| E. 1959-1960 Window Motor Trans., L or R, used | \$80.00 |
| F. 1958-1960 Transmission to Motor Coupler     | \$11.00 |
| G. 1961-1964 Window Motor Trans., Rebuilt      | \$55.00 |
| Core Charge on Window Transmission             | \$30.00 |
| 1961-1964 Window Transmission Gear, new        | \$25.00 |
| H. 1961-1964 Transmission to Motor Coupler     | \$11.00 |
| J. 1964-1966 Motor Gear Cover, new             | \$ 4.95 |
| K. 1964-1966 Motor Gear Cover Gasket, new      | \$ 1.95 |
| L. 1964-1966 Motor Gear, new                   | \$24.95 |
| M. 1964-1966 Vent Window Trans. Gear, new      | \$30.00 |

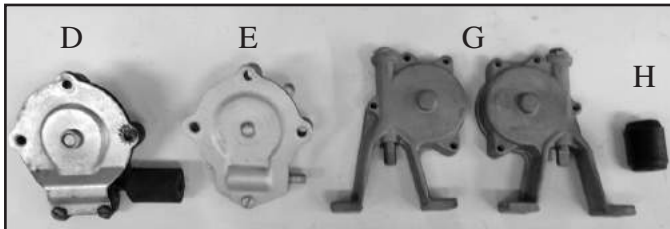

## Window Regulators and Parts

- |                                       |          |
|---------------------------------------|----------|
| 1958-1960 Power, Front or Rear, used  | \$ 75.00 |
| 1958-1960 Manual, Front or Rear, used | \$100.00 |
| 1958-1960 Window Track Roller, new    | \$ 2.25  |
| 1961-1963 Power, Rear, used           | \$ 75.00 |
| 1961-1963 Manual, Front or Rear, used | \$ 75.00 |
| 1961-1964 Power, Front, used          | \$ 75.00 |
| 1961-1966 Window Track Roller, new    | \$ 1.50  |
| 1964-1966 Manual, Front or Rear, used | \$ 75.00 |
| 1965-1966 Power, Front or Rear, used  | \$ 50.00 |

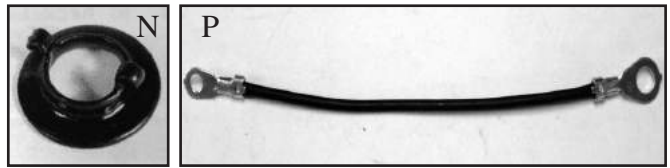

## Wiring Harnesses

- |   |          |
|---|----------|
| 1958-1963 Headlight Socket Lead, new                                | \$ 37.00 |
| 1958-1960 Engine Compartment Harness, without Air Conditioning, new | \$250.00 |
| with Air Conditioning, new  | \$275.00 |
| 1961-1962 Engine Compartment Harness, new                           | \$265.00 |
| 1963 Engine Compartment Harness, new                                | \$340.00 |
| 1964 Engine Compartment Harness, new                                | \$330.00 |
| 1965 Engine Compartment Harness, new                                | \$335.00 |
| 1966 Engine Compartment Harness, new                                | \$365.00 |
| 1963 Alternator Harness, new  | \$150.00 |
| 1964-1965 Alternator Harness, new                                   | \$ 95.00 |
| 1966 Alternator Harness, new  | \$ 45.00 |
| 1964-1966 Front Body Harness, Hardtop                               | CALL     |
| 1964-1966 Front Body Harness, Convertible                           | CALL     |
| 1958-1960 Dash Harness, new   | \$475.00 |
| 1961-1962 Dash Harness  | CALL     |
| 1963 Dash Harness   | CALL     |
| 1964-1966 Dash Harness  | CALL     |
| 1958-1959 Body Harness, Hardtop, new                                | \$155.00 |
| 1960 Body Harness, Hardtop, new                                     | \$200.00 |
| 1958-1959 Body Harness, Convertible, new                            | \$325.00 |
| 1959-1960 Body Harness, Convertible, new                            | \$430.00 |
| 1961-1962 Body Harness, Convertible, new                            | \$370.00 |
| 1964-1966 Rear Body Harness, Hardtop                                | CALL     |
| 1964-1966 Rear Body Harness, Convertible, new                       | \$370.00 |
| 1959-1960 Conv. Relay Harness, for 10 Relays, new                   | \$445.00 |
| 1959-1960 Conv. Relay Harness, for 12 Relays, new                   | \$510.00 |
| 1961-1963 Convertible Relay Harness, new                            | \$460.00 |
| 1964-1966 Convertible Relay Harness, new                            | \$475.00 |
| 1959-1963 Convertible Trunk Lid Harness, new                        | \$250.00 |
| 1964-1966 Convertible Trunk Lid Harness, new                        | \$250.00 |

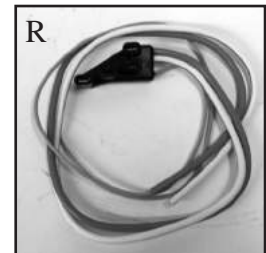

## Wiring Accessories

- |   |         |
|---|---------|
| N. 1958-1960 Engine Comp. Wiring Grommet    | \$ 3.50 |
| 1958-1960 Firewall Wiring Grommet           | \$ 3.00 |
| 1958-1960 Firewall Wiring Grommet Retainer  | \$10.00 |
| 1958-1960 Engine Compartment Wiring Clip    | \$ 1.00 |
| 1958-1966 Engine Compartment Wiring Strap   | \$ .65  |
| P. 1958-1963 Engine to Body Ground Strap    | \$10.00 |
| Q. 1958-1966 Relay Plug Repair, 3-wire, new | \$14.95 |
| R. 1958-1966 Relay Plug Repair, 4-wire, new | \$16.95 |

# Electrical Parts

## Power Seat Switches

1958 Switch with Black Knob, new	\$ 75.00
1959-1960 Switch with White Knob, new	\$ 75.00
1961-early 1962 7-wire Switch, new	\$ 75.00
Late 1962-1963 5-wire Switch, new	\$ 75.00
A. 1964-1965 5-wire Switch, new	\$ 75.00
1966 3 Switch Assembly, used	CALL
1958-1965 Switch Repair Kit	\$ 19.95
1966 Switch Knob and Stem, new	\$ 25.00

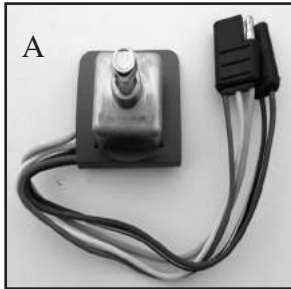

## Power Seat Switch Bezels

1958-1960 Seat Switch Bezel/Nut, used	\$20.00
1961-1963 Seat Switch Bezel, used	\$30.00
1961-1963 Seat Switch Bezel Nut, used	\$20.00
1964-1965 Seat Switch Bezel and Nut, new	\$29.95
B. 1964-1965 Seat Switch Bezel, used	\$20.00

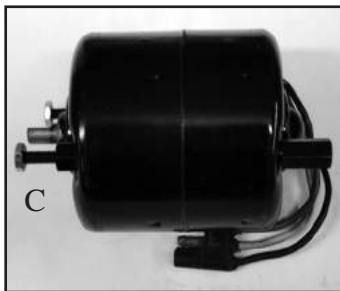

## Power Seat Motors

1958-1966 Rebuilt	\$110.00
C. 1958-1960 New	\$185.00
D. 1961-1963 New	\$185.00
1964-1965 New	\$185.00
1966 Rebuilt	\$110.00
Core Charge on all rebuilt Motors	\$ 50.00

## Seat Bases and Parts

1958-1965 Power Seat Base, with Switch, used	\$250.00
1966 Power Seat Base, with Switch, used	\$275.00
1958-1966 Power Seat Relays	\$ 49.95
1958-1966 Power Seat Wiring Harnesses	CALL
1958-1960 Manual Seat Tracks	\$ 55.00
1961-1963 Manual Seat Tracks	\$ 55.00
1964-1966 Manual Seat Tracks	\$ 55.00
1958-1966 Seat Track Studs, with Nut, new, each	\$ 2.50

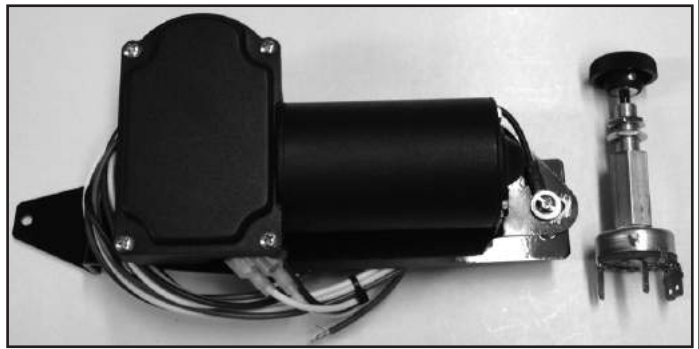

## Electric Wiper Motor Conversion

1958-1960 Windshield Wiper Drive	\$296.95
Bolts directly to the original mounting plate and cable spool. Comes with 2-speed switch and switch shaft extension to keep a stock appearance.	
1958-1960 Intermittent Delay Switch	\$ 85.00
Allows 2-speed operation with intermittent delay. Mounts in original position with switch shaft extension to appear stock. Connects directly to the new motor.	

## Wiper Motors & Parts

1961-1962 Good Used	\$150.00
1961-1962 Wiper Switch and Cable, used	\$ 45.00
1963 Rebuilt	\$225.00
1963 Wiper Switch and Cable, used	CALL
1964-1966 Rebuilt	\$225.00
1964-1966 Wiper Controller and Cable, used	\$ 55.00
Core Charge on all Rebuilt Wiper Motors	\$ 75.00

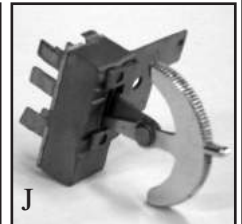

## Heater Blower Motor

E. 1958-1966 Rebuilt	\$110.00
Core Charge on all rebuilt Motors \$ 75.00	
F. 1961-1966 Blower Motor Hose, Single 90°	\$ 4.00
G. 1961-1966 Blower Motor Hose, Double 90°	\$ 7.00
1958-1960 Blower Switch, used	CALL
H. 1961-1963 Blower Switch, used	CALL
J. 1964-1966 Blower Switch, new	\$ 80.00

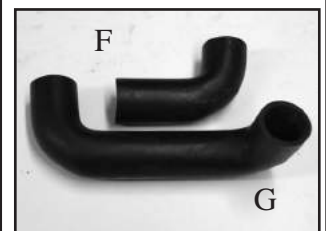

For monthly specials, please visit our website: [www.wilsontbird.com](http://www.wilsontbird.com)



# Lights and Lenses

## Headlights

1958-1960 Headlight Door, L or R, used	\$ 50.00
1958-1965 Headlight Bulb Buckets, used, each	\$ 15.00
1958-1965 Headlight Bulb Rings, used, each	\$ 10.00
1958-1966 Headlight Bulb, Halogen, each	\$ 15.00
1961-1963 Headlight Door, L or R, new, each	\$ 45.00
1961-1963 Headlight Bezels, new, pair	\$575.00
1964-1965 Headlight Bucket, L or R, used	\$150.00
1964-1965 Headlight Door, L or R, new	\$ 79.95
1966 Headlight Bucket, L or R, used	\$150.00
1966 Headlight Bulb Buckets, used, each	\$ 20.00
1966 Headlight Bulb Rings, used, each	\$ 20.00



## Parking Lights

A. 1958-1960 Parking Light Lens, pair	\$ 15.00
B. 1958-1960 Parking Light Lens Gasket, each	\$ 3.50
C. 1958-1960 Parking Light Body, new, each	\$ 60.00
D. 1961-1963 Parking Light Lens, Clear, pair	\$ 14.00
E. 1962-1963 Parking Light Lens, Amber, pair	\$ 16.00
1961-1963 Parking Light Body, new, pair	\$230.00
F. 1961-1963 Parking Light Lens Gasket, each	\$ 3.50
G. 1964-1965 Parking Light Lens, Amber, pair	\$ 13.00
H. 1964-1965 Parking Light Lens, Clear, pair	\$ 13.00
J. 1964-1965 Parking Light Lens Gaskets, each	\$ 3.50
K. 1966 Parking Light Lens, R or L, each	\$ 30.00
L. 1966 Parking Light Lens Gasket, each	\$ 3.50

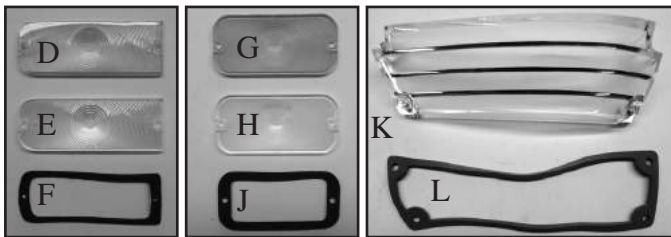

## Fender Marker Lights

M. 1964-1965 Pair	\$85.00
1966 Pair	\$85.00



## Interior Lights

N. 1958-1960 Dome Light Lens, new	\$ 8.00
P. 1958-1960 Dome Light Bezel, new	\$18.00
1958-1960 Hardtop Map Light Panel, used	CALL
Q. 1961-1963 Dome Light Bezel Assembly	\$25.00
R. 1961-1963 Map Light Lens, new	\$ 4.00
1961-1963 Map Light Panel, used	\$40.00
S. 1964-1966 Dome Light Assembly, L or R, each	\$36.00
T. 1961-1966 Dome or Door Light Lens, each	\$ 8.00
1963-1966 Door Courtesy Light Housing, used	\$20.00
U. 1963-1964 Door Courtesy Light Lens Assy., new	\$37.00
V. 1965-1966 Door Courtesy Light Assembly, new	\$43.00
1964-1966 Map Light Lenses, new, pair	\$10.00
1964 Map Light Switch, used	\$45.00
1965-1966 Map Light Switch, used	\$35.00
1964-1966 Interior Light Relay, used & tested	\$35.00
W. 1966 Landau Dome Light Lens, new	\$ 8.00
1966 Landau Dome Light Assembly, used	\$20.00
1958-1966 Door Jam Switch, new	\$ 9.50

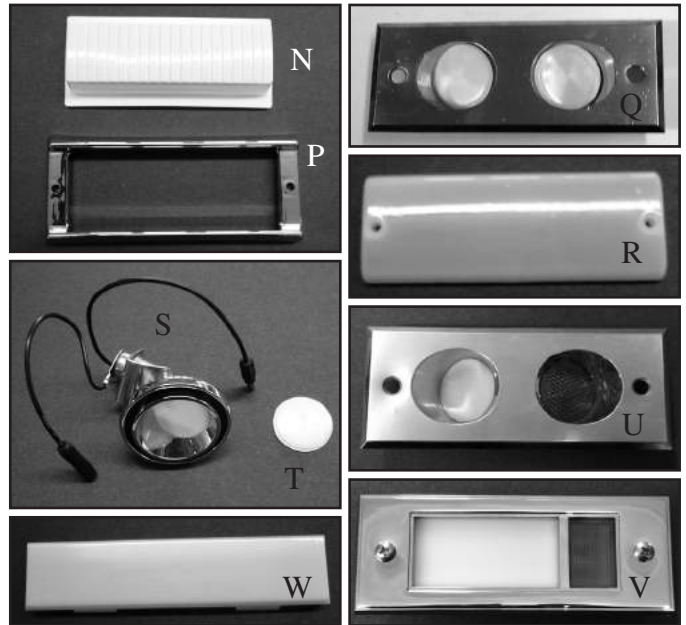

## Tail Light Buckets

X. 1961 Tail Light Bucket, new	\$70.00
Y. 1961 Tail Light Bucket Retainer	\$25.00
Z. 1962-1963 Tail Light Bucket, new	\$90.00
a. 1962-1963 Tail Light Bucket Retainer	\$25.00
1964-1965 Tail Light Housing, used	CALL
1966 Left, Right, or Center Housing, used	CALL



# Lights and Lenses

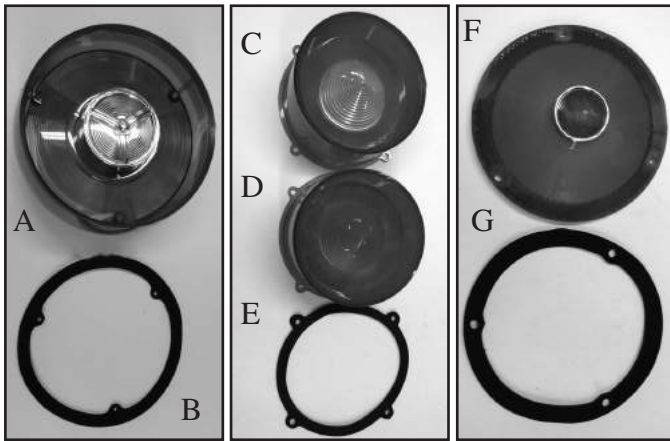

## Tail Light Lenses

A. 1958-1959 New	\$35.00
1958-1959 Used	\$20.00
B. 1958-1959 Gasket	\$ 3.50
C. 1960 New, w/ Backup Lens	\$35.00
D. 1960 New, w/o Backup Lens	\$30.00
1960 Used	\$15.00
E. 1960 Gasket	\$ 3.50
F. 1961 New	\$30.00
G. 1961 Gasket	\$ 3.50
1962-1963 New	\$40.00
1962-1963 Used	\$20.00
1962-1963 Gasket	\$ 3.50
H. 1964 New	\$60.00
1964 Used	\$30.00
1964 Gasket	\$ 5.50
J. 1965 New	\$40.00
1965 Used	\$20.00
1965 Gasket	\$ 5.50
K. 1966 Outer, new	\$60.00
1966 Outer, used	\$30.00
1966 Gasket	\$ 5.50
L. 1966 Center w/ Backup Lens	\$70.00
1966 Gasket	\$ 5.50
1961-1966 Tail Light Socket, replacement	\$ 9.95



## Tail Light Rings and Bezels

M. 1958-1959 Tail Light Ring, new	\$ 19.00
N. 1962 Tail Light Ring, new	\$ 10.00
1962 Tail Light Ring, used	\$ 5.00
P. 1963 Tail Light Ring	\$ 49.95
Q. 1964 Tail Light Bird Emblem, new	\$ 22.00
R. 1965 Tail Light Bezel, new	\$ 90.00
1966 Tail Light Bird Emblem, new	\$ 45.95



## Reverse Lights

S. 1961-1963 Lens, new	\$ 6.00
T. 1961-1963 Gaskets, each	\$ 3.50
1961-1963 Reverse Light Housings, pair	\$200.00
U. 1964-1965 Glass Lens, new	\$ 25.00
1964-1965 Glass Lens, used	\$ 10.00
V. 1964-1965 Gaskets, each	\$ 3.50
W. 1964-1965 Chrome Bezels, new, each	\$ 25.00

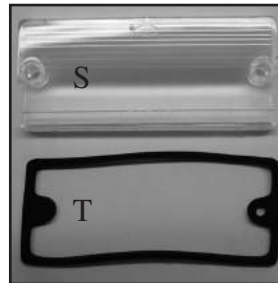

## License Plate Lights

X. 1958-1960 License Plate Light Assy., 2 Req.	\$ 12.00
1961-1963 License Plate Light Assy., 2 Req.	\$ 12.00
Y. 1964-1966 License Plate Light Lens, glass	\$ 8.00
1958-1963 License Plate Light Brackets, used	CALL
Z. 1964 License Plate Light Assembly, used	CALL
1965-1966 License Plate Light Assy., used	CALL

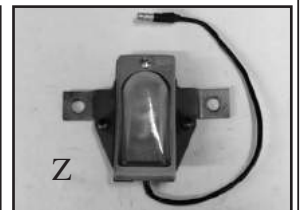
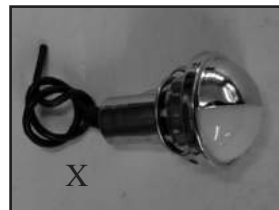



# Mirrors, Rims, and Hubcaps

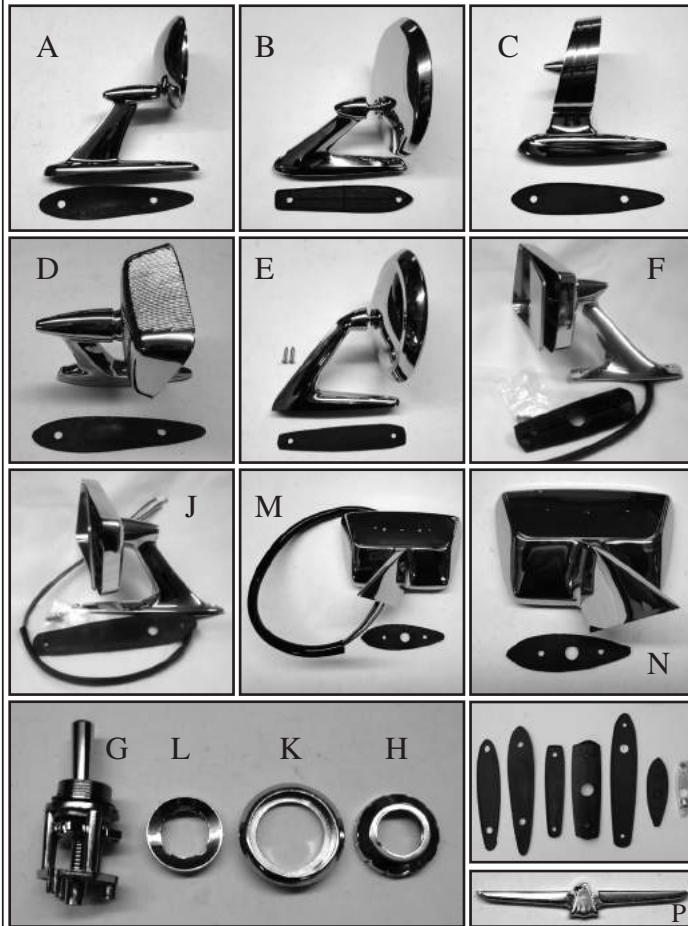

## Outside Mirrors

A. 1957-1958 Round Head, 2-Hole Type	\$ 40.00
1957-1958 Mirror Gasket	\$ 6.00
B. 1958-1963 Universal Round Head	\$ 35.00
C. 1958-1959 Select-o-Ring Mirror	\$140.00
1958-1959 Mirror Gasket	\$ 6.00
D. 1960 Hooded Mirror	\$130.00
1960 Mirror Gasket	\$ 6.00
E. 1961-1962 Exact Reproduction	\$ 95.00
1961-1962 Mirror Gasket	\$ 6.00
F. 1963 Left, with Remote	\$140.00
1963 Right, without Remote, Convex Glass	\$125.00
1963 Mirror Gasket	\$ 6.00
G. 1963-1966 Remote Mirror Controller	\$ 34.95
H. 1963 Remote Controller Bezel Nut	\$ 12.95
J. 1964 Left, with Remote	\$140.00
1964 Right, without Remote, Convex Glass	\$125.00
K. 1964-1966 Remote Controller Bezel	\$ 10.95
L. 1964-1966 Remote Controller Bezel Nut	\$ 10.00
1964 Mirror Gasket	\$ 6.00
M. 1965-1966 Left, w/ Remote, w/o Bird Emblem	\$165.00
N. 1965-1966 Right, without Bird Emblem	\$140.00
P. 1965-1966 Bird Emblem for L & R Mirrors	\$ 20.00
1965-1966 Mirror Mounting Bracket	\$ 10.00
1965-1966 Mirror Gasket	\$ 6.00

All outside mirrors come with mounting gaskets.

## Inside Mirrors

Q. 1958-1959 Inside Mirror	\$ 35.00
R. 1960 Inside Mirror	\$ 69.95
S. 1958-1960 Inside Mirror Mount	\$ 19.95
T. 1961-1964 Inside Day/Nite Push Button	\$ 42.95
U. 1964-1966 Inside Day/Nite Twist	\$ 42.95
V. 1961-1966 Inside Mirror Stantion	\$ 22.50
W. 1961-1966 Inside Mirror Plug	\$ 5.00



## Hubcaps

1958-1960 Sunray Emblems with Retainers, each	\$ 60.00
1959-1960 Hubcap, new, each	\$110.00
1958-1966 Standard Hubcap, used, each	\$ 50.00
1963-1966 Deluxe (with Spinner), used, each	CALL
1964-1966 Hubcap Decals, Black	\$ 22.00
1965 Special Landau Hubcap Decals, Emberglow	\$ 23.00
1965 Deluxe Hubcap Center Emblem, Tri-color	\$ 40.00
1966 Deluxe Hubcap Center Emblem, Red	\$ 29.95

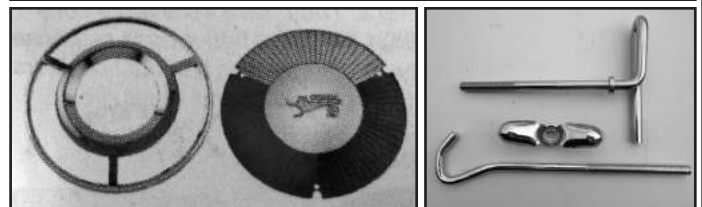

## Spare Tire Hold Downs

1958-1963 T-Type	\$ 14.95
1962-1964 KH Wheel Center Hole Adapter	\$ 5.00
1964-1966 J. Bolt	\$ 6.00
1961-1966 Wing Nut	\$ 3.00

## Steel Rims, Original Used

1958-1960	\$ 95.00
1961-1963	\$ 95.00
1964	\$ 95.00
1965-1966 with Correct Offset for Calipers	\$ 95.00
1958-1966 Wheel Studs, each	\$ 3.25
1958-1966 Lug Nuts, each	\$ .50



# Trim, Emblems, and Moldings

## Hood and Front Bumper

A. 1958-1959 Nose Panel Ornament	\$ 35.00
B. 1960 Nose Panel Ornament	\$ 40.00
1958-1960 Headlight Doors, used	CALL
C. 1961-1963 Center Hood Molding	\$ 60.00
D. 1961-1963 Hood Molding Ends (Eyebrows), ea.	\$ 45.00
E. 1961-1963 Hood Bird Emblem, Chrome	\$ 40.00
F. 1961-1963 Hood Bird Insert, Plastic	\$ 35.00
G. 1961-1963 Chrome Hood Scoop, new	\$175.00
1961-1963 Headlight Doors, new, each	\$ 45.00
H. 1964 Hood Letters, set of 13	\$ 35.00
J. 1965 Hood Bird	\$ 45.00
K. 1964-1965 Chrome Hood Scoop, new	\$175.00
L. 1966 Chrome Hood Scoop ("V")	\$ 70.00
1964-1965 Headlight Doors, new, each	\$ 79.95
1966 Headlight Doors, used	CALL
1964-1965 Headlight Buckets, used	CALL
1966 Headlight Buckets, used	CALL
1960 Grille Center Emblem, 4 piece set	\$225.00
M. 1966 Grille Bird Emblem	\$140.00
N. 1966 Grille Side Moldings (Eyebrows), each	\$ 59.95
1958-1966 Grille Assemblies, used	CALL
1958-1966 Front Bumpers, used	CALL
1958-1960 Bumperettes, used	CALL
1961-1963 Bumper Over-riders, new	\$295.00
1964-1965 Bumperettes, used	CALL
1966 Bumperettes, used	CALL
1958-1966 Front Bumper Brackets, used	CALL

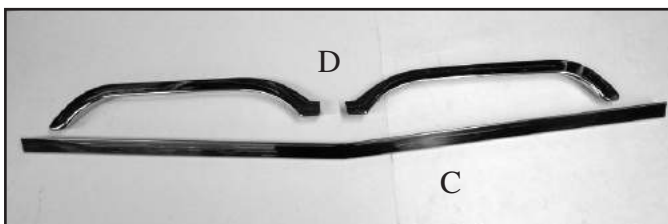
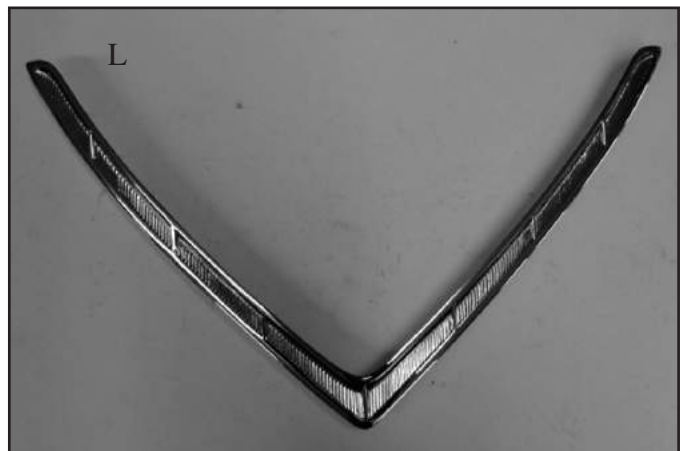
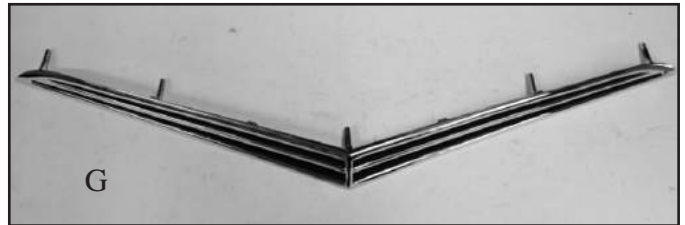
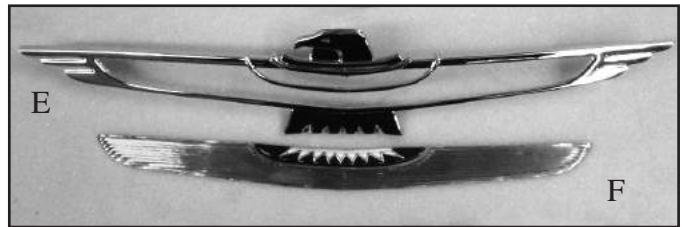

# Trim, Emblems, and Moldings

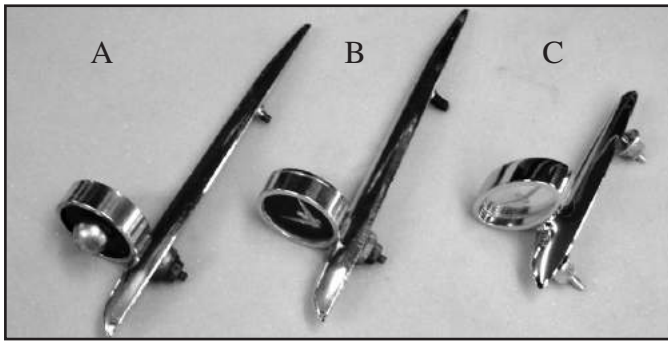

## Front Fenders

- A. 1958 Fender Top Ornament, each \$ 65.00
- B. 1959 Fender Top Ornament, each \$ 65.00
- C. 1960 Fender Top Ornament, each \$ 65.00
- D. 1964-1965 Fender Top Turn Indicators, pair \$ 85.00
- 1966 Fender Top Turn Indicators, pair \$ 85.00
- E. 1958 Fender Script \$ 25.00
- E. 1961-1962 Fender Script \$ 25.00
- F. 1964 Fender Script \$ 35.00
- G. 1962-1963 Fender Roadster Emblem, each \$ 25.00  
(also used on Tonneau Cover)
- H. 1965 Fender C-Molding and Feathers, \$ 85.00  
Left or Right, each
- 1961-1966 Side Body Molding Kit \$280.00
- 1961-1963 Fender Top Peak Molding, L or R, ea. \$105.00
- 1966 Front Wheel Lip Moldings, used CALL

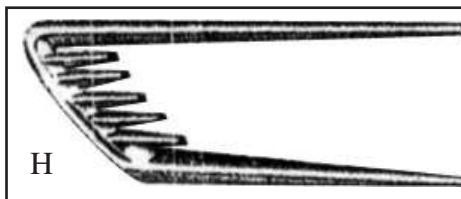
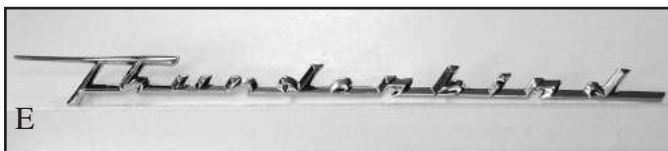

## Doors

- J. 1958 Door Emblems, 10 Required, each \$ 17.95
- K. 1959 Door Spears, Left or Right, each \$ 99.95
- E. 1959 Door Script \$ 25.00
- 1960 Door Script CALL
- L. 1963 Door Emblems, 6 Required, each \$ 21.00
- M. 1958-1960 Outer Door Handles, Left and \$140.00  
Right, with Buttons, pair
- 1958-1960 Outer Door Handle Buttons, each \$ 20.00
- N. 1961-1963 Outer Door Button Assembly, each \$ 29.00
- P. 1961-1963 Outer Door Button Bezel, each \$ 20.00
- 1961-1963 Door Peak Molding, Left or \$104.00  
Right, each
- Q. 1964-1966 Outer Door Handle, Left or Right, \$ 75.00  
without Buttons, each
- R. 1964-1966 Door Handle Button, each \$ 18.00

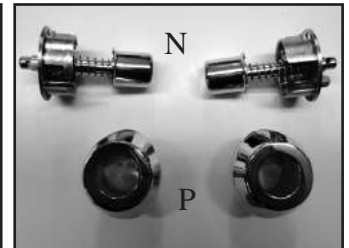
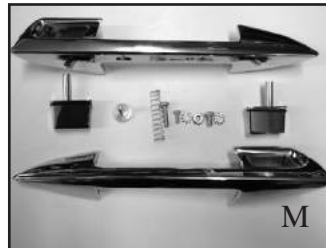
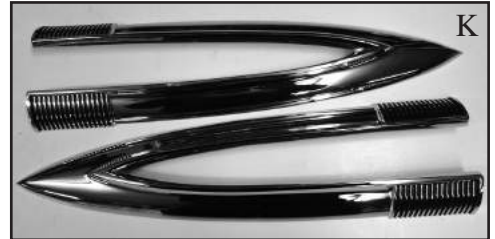
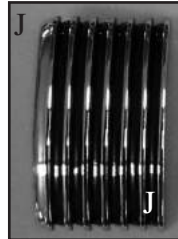

# Trim, Emblems, and Moldings

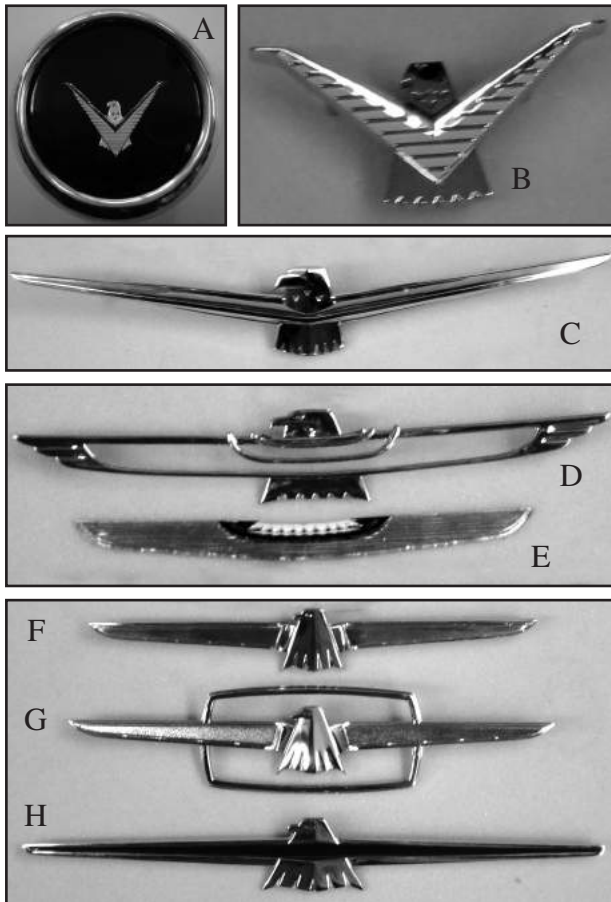

## Roof

1958-1966 Front Windshield Trim, used	CALL
1958-1966 Roof Rail Trim, used	CALL
A. 1958 Roof Side Ornaments, pair	\$ 90.00
B. 1959 Roof Bird Emblem, each	\$ 40.00
C. 1960 Roof Bird Emblem, each	\$ 38.50
D. 1961-1963 Roof Bird Emblem, Chrome, each	\$ 38.00
E. 1961-1963 Roof Bird Plastic Insert, each	\$ 25.00
F. 1964 Roof Bird Emblem, each	\$ 42.00
G. 1965 Roof Bird Emblem, each	\$ 42.00
H. 1966 Roof Bird Emblem, each	\$ 42.00
J. 1962-1963 Landau Bars, pair	\$139.95
1962-1963 Landau Bar Medallion Insert	\$ 29.95
K. 1964 Landau Bars, pair	\$139.95
1964 Landau Bar Insert, Black or White, each	\$ 29.95
L. 1965 Landau Bars, pair	\$139.95
M. 1966 Landau Bars, pair	\$139.95
1966 Landau Bar Medallion Insert, each	\$ 29.95
N. 1958-1959 Roof Side Moldings, pair	\$149.95
P. 1960 Roof Side Moldings, pair	\$149.95
1961-1963 Roof Side Moldings, used, pair	\$ 80.00
Q. 1964 HT Roof Side Moldings, pair	\$149.00
R. 1964 Landau Roof Side Moldings, pair	\$179.95
S. 1965-1966 HT Roof Side Moldings, pair	\$149.95
1958-1966 Rear Window Trim, used	CALL

## Quarter Panels

1958-1960 Quarter Panel Extensions (Cat's Eyes), Left or Right, new, each	\$ 95.00
1958-1960 Quarter Panel Extensions, Left or Right, used, each	\$ 60.00
1958-1960 Rear Molding from Cat's Eye to Bumperette, used, each	\$ 60.00
1960 Quarter Panel Bars, with Holes, Set of 9	\$119.95
1960 Quarter Panel Bars, with Pins, Set of 9	\$119.95
T. 1961 Quarter Panel Spears, 8 Required, each	\$ 17.00
U. 1962 Quarter Panel Emblems, 6 Required, each	\$ 25.00
1963 Quarter Panel Script (F on Page 42)	\$ 35.00
V. 1965-1966 Quarter Panel Script	\$ 30.00
1961-1963 Quarter Panel Peak Molding, Left or Right, each	\$104.00
1961-1963 Quarter Peak Molding End Cap, ea.	\$ 30.00
1966 Rear Wheel Lip Moldings, used	CALL
1965-1966 Skirt Moldings, used	CALL

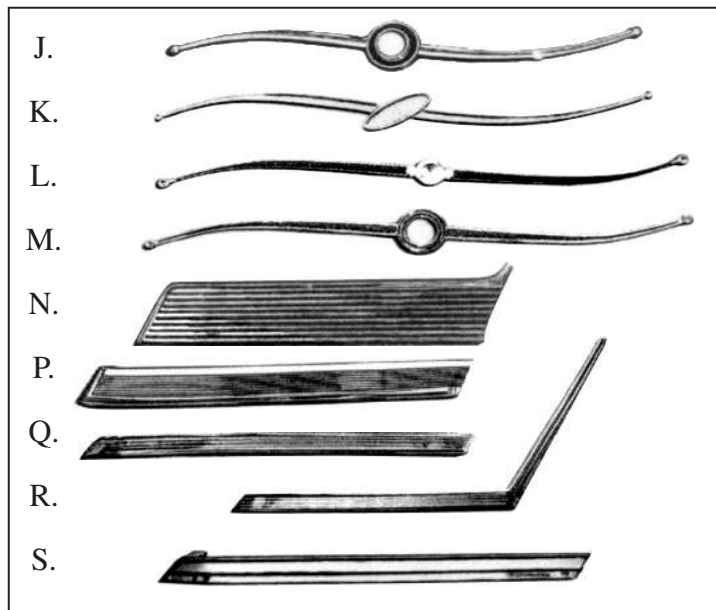
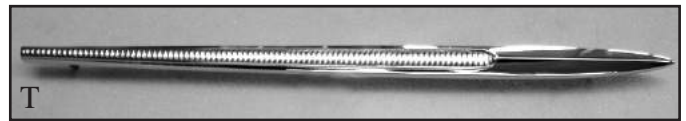



# Trim, Emblems, and Moldings

## Rear Bumpers

1961-1963 Fuel Filler Door, Chrome, new	\$ 79.95
A. 1964-1965 Rear Bumper Chrome Center	\$ 80.00
B. 1964 Rear Bumper Center Emblem	\$ 45.00
C. 1965 Rear Bumper Center Emblem	\$ 45.00
D. 1964-1965 Rear Bumper Emblem Retainer	\$ 12.00
1958-1966 Rear Bumpers, used	CALL
1958-1960 Rear Bumper Center Bullets, used	CALL
E. 1961-1963 Rear Bumper "Q", new, each	\$349.95
1958-1966 Rear Bumper Brackets, used	CALL

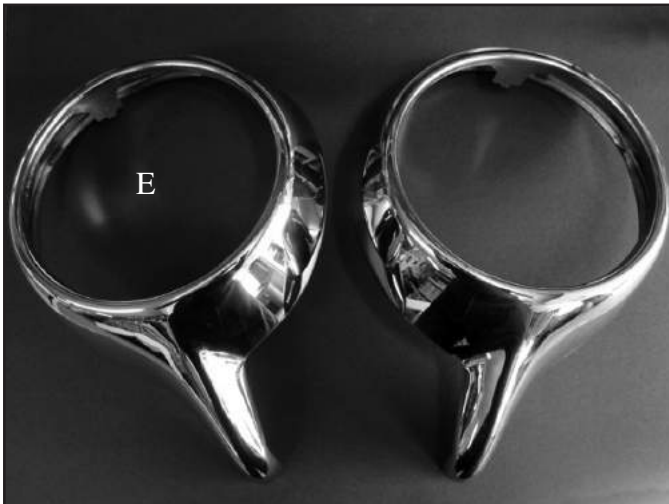
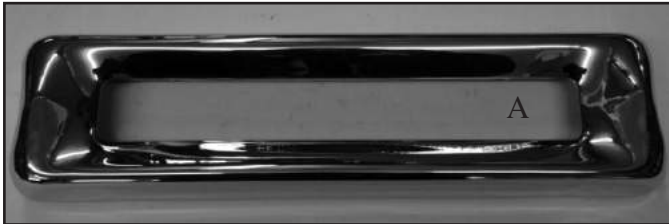

We also stock the attaching hardware (barrel clips, speed nuts, etc.) for all trim, emblems, and moldings. Please see pages 50-51 for a complete listing of all fasteners.

## Trunk Lid

F. 1958-1959 Trunk Lock Ornament, w/o Cylinder	\$104.95
G. 1960 HT Trunk Lock Ornament, w/o Cylinder	\$ 99.95
H. 1960 Hardtop Trunk Lock Flipper Only	\$ 35.00
1960 Convertible Trunk Ornament	\$109.95
J. 1961-1963 Hardtop Trunk Lock Ornament, Chrome, w/o Lock Cylinder	\$ 85.00
K. 1961-1963 Trunk Ornament Plastic Insert	\$ 25.00
L. 1961-1963 Hardtop Trunk Lock Flipper Only	\$ 35.00
1961-1963 Conv. Trunk Ornament, Chrome	\$ 95.00
M. 1964 HT Trunk Lock Ornament, w/o Cylinder	\$ 80.00
1964 Hardtop Trunk Lock Flipper Only	\$ 45.00
N. 1965-1966 HT Trunk Lock Ornament, w/o Cyl.	\$ 80.00
P. 1965-1966 Trunk Lock Flipper Only	\$ 45.00
Q. 1964-1966 Trunk Lock Flipper Insert, Primed	\$ 7.00
R. 1964 Trunk Lock Ornament Gasket	\$ 2.00
S. 1965-1966 Trunk Lock Ornament Gasket	\$ 2.00

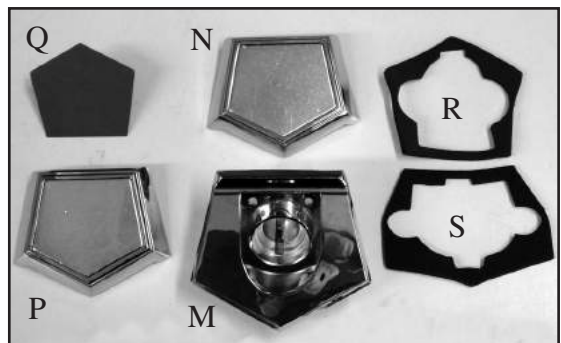
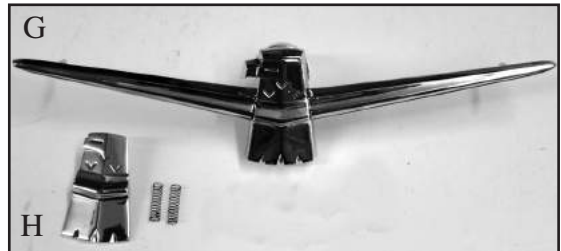

# Weatherstrip and Rubber Parts

**1958-1960**

A. Front Bumper to Fender Seals, pair	\$ 20.00
B. Rear Bumper to Body Seals, pair	\$ 15.00
C. Rear Bumper Guard Rubber Filler	\$ 29.00
Parking Light Gasket, each	\$ 3.50
Outer Headlight Bucket Gaskets, pair	\$ 10.00
D. Hood Bumpers, set of 4	\$ 10.00
Hood to Cowl Bumpers, set of 2	\$ 10.00
E. Center Cowl Hood Bumpers, pair	\$ 8.00
Hood to Cowl Seal	\$ 10.00
Hood Pad Set, 6 Pieces	\$ 45.00
F. Door Bumpers, pair	\$ 5.00
Windshield Weatherstrip, Hardtop or Conv.	\$ 92.50
Windshield Post Weatherstrip, Hardtop, pair	\$ 18.00
G. Windshield Post Weatherstrip, Convertible, pr.	\$ 45.00
Door Weatherstrip, Hardtop or Convertible, pr.	\$ 85.00
H. Door Rubber Seals at Belt Line, pair	\$ 20.00
Vent Window Door Glass Channel, pair	\$ 60.00
J. Vent Window Weatherstrip, pair	\$ 85.00
K. Vent Window Division Bar Weatherstrip, pair	\$ 19.00
Vent Window Tips, pair	\$ 20.00
L. Belt Line Weatherstrip Kit, Hardtop Or Conv.	\$ 95.00
M. Convertible Top Arm Pads, pair	\$ 80.00
N. Quarter Post Seals (Dog Ears), pair	\$ 20.00
Quarter Window to Door Glass Seals, pair	\$ 25.00
Roof Rail Weatherstrip, Hardtop, pair	\$199.95
Roof Rail Weatherstrip, Convertible, 9 Pieces	\$350.00
P. Outside Door Handle Gaskets, 4 Pieces	\$ 10.00
Q. Antenna Grommet Pad	\$ 6.00
Outside Mirror Pad	\$ 6.00
Skirt Seals, pair	\$ 14.00
R. Fender Splash Edge Seals, 4 piece set	\$ 15.00
Rear Window Weatherstrip Hardtop	\$149.95
S. Trunk Weatherstrip Hardtop	\$ 22.00
T. Trunk Weatherstrip Kit, Convertible	\$ 79.95
Fuel Filler Neck Grommet	\$ 10.00
License Plate Bumpers, pair	\$ 5.00
1958-1959 Tail Light Lens Gasket, each	\$ 3.50
1960 Tail Light Lens Gasket, each	\$ 3.50
Steering Column Seal	\$ 4.50
Firewall Wiring Grommet	\$ 3.00
Firewall Grommet Retaining Ring	\$ 10.00

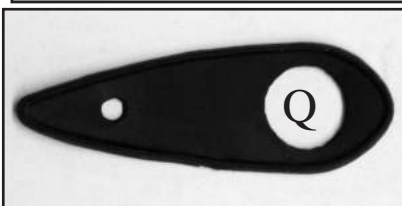
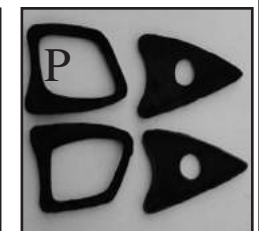
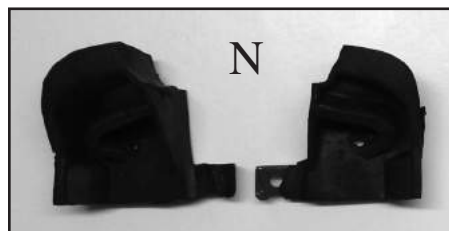
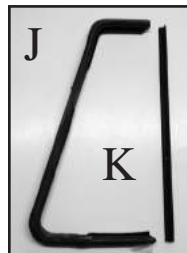
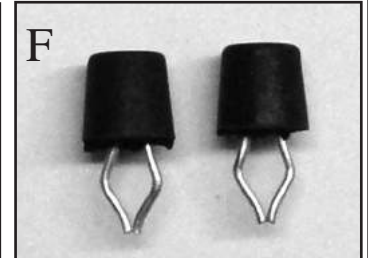
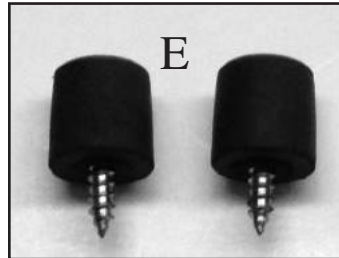

For monthly specials, please visit our website: [www.wilsontbird.com](http://www.wilsontbird.com)

# Weatherstrip and Rubber Parts

**1961-1963**

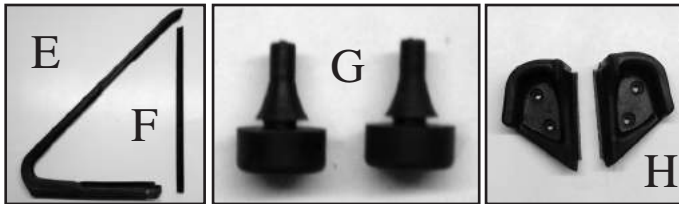
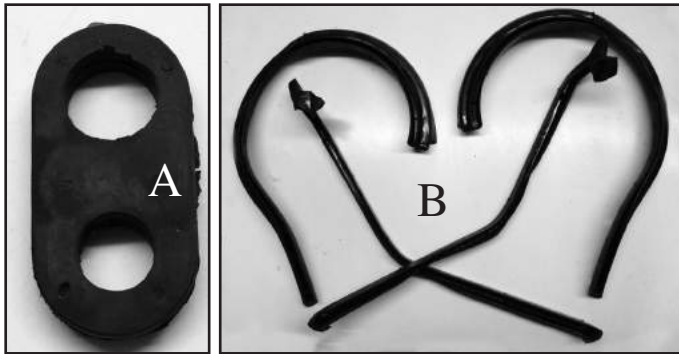

- |   |          |
|---|----------|
| A. AC Hose through Fire Wall Grommet                | \$ 10.00 |
| Windshield Weatherstrip, Hardtop                    | \$100.00 |
| Windshield Weatherstrip, Convertible                | \$140.00 |
| Rear Window Weatherstrip, Hardtop                   | \$ 89.95 |
| Door Weatherstrip Hardtop or Convertible, pair      | \$ 85.00 |
| B. Fender to Bumper Seals Front and Rear, 4 pc. set | \$210.00 |
| Rear only Bumper to Body Seals, 2 piece set         | \$140.00 |
| C. 1962-1963 Radiator Support to Hood Seal          | \$ 8.00  |
| Hood to Cowl Seal                                   | \$ 10.00 |
| Hood Wedge Bumpers, set of 4                        | \$ 12.00 |
| Hood Bumpers at Radiator Support, pair              | \$ 10.00 |
| D. Windshield Post Pillar Weatherstrip, Conv., pair | \$ 50.00 |
| E. Vent Window Weatherstrip, pair                   | \$ 85.00 |
| F. Vent Window Division Bar Weatherstrip, pair      | \$ 19.00 |
| Vent Window Tips, pair                              | \$ 20.00 |
| G. Upper Door Bumpers, 2 required, pair             | \$ 5.00  |
| Lower Door Bumpers, 2 required, pair                | \$ 4.00  |
| Lower Door Drain Seals, 6 required, each            | \$ 3.00  |
| Quarter Window to Door Glass Seals, pair            | \$ 25.00 |
| H. Quarter Post Seals (Dog Ears), pair              | \$ 18.00 |
| Trunk Weatherstrip, Hardtop                         | \$ 22.00 |
| J. Trunk Weatherstrip Kit, Convertible              | \$ 80.00 |
| Accelerator Linkage Through Firewall Seal           | \$ 5.00  |
| Roof Rail Weatherstrip, Hardtop, pair               | \$199.95 |
| Roof Rail Weatherstrip, Convertible, 7 piece set    | \$225.00 |
| K. Convertible Top Arm Pads, pair                   | \$ 80.00 |
| L. Skirt Seals, pair                                | \$ 14.00 |
| Belt Line Weather-Strip, HT or Convertible, set     | \$125.00 |
| M. Convertible Front Header Seal, Inner             | \$ 40.00 |
| N. Conv. Front Header Seal, Outer (Black or White)  | \$ 43.00 |
| Parking Light Lens Gaskets, each                    | \$ 3.50  |
| 1961 Tail Light Lens Gaskets, each                  | \$ 3.50  |
| 1962-1963 Tail Light Lens Gaskets, each             | \$ 3.50  |
| Back Up Light Lens Gaskets, each                    | \$ 3.50  |
| Tail Light Bucket to Bumper Seals, pair             | \$ 15.00 |
| Division Bar Channel Liner (Fuzzy)                  | \$ 7.00  |
| P. 1961-1963 Fresh Air Inlet Seal                   | \$ 40.00 |
| Trans. Cooler Line Hose (Braided Like Original)     | \$ 10.00 |
| Q. Cowl Drain Tubes, pair                           | \$ 33.00 |
| Steering Column to Firewall Boot                    | \$ 30.00 |



# Weatherstrip and Rubber Parts

**1964-1966**

Windshield Weatherstrip, Hardtop Or Convertible	\$ 89.95
Back Window Weatherstrip, Hardtop	\$ 89.95
A. 1964-1966 Door Weatherstrip, USA made, pair	\$ 99.00
Door Bumpers, Upper, pair	\$ 5.00
Door Bumpers, Lower, pair	\$ 4.00
Lower Door Drain Seals, each	\$ 3.00
B. Vent Window Weatherstrip, pair	\$ 85.00
C. Vent Window Division Bar Seals, pair	\$ 19.00
D. Vent Window Tips, pair	\$ 20.00
E. Vent Window Front Edge Flap Seals, pair	\$ 19.00
F. Quarter Window to Door Glass Weatherstrip, pair	\$ 25.00
G. Quarter Post Seals (Dog Ears), pair	\$ 18.00
1966 Tail Light Lens Gaskets, Outer, each	\$ 5.50
1966 Tail Light Lens Gasket, Center	\$ 5.50
1964-1965 Tail Light Lens Gaskets, each	\$ 5.50
Back Up Light Lens Gaskets, pair	\$ 6.00
Gas Door Bumpers, each	\$ 2.00
Outside Mirror Gasket	\$ 6.00
Antenna Base Gasket	\$ 4.00
Vent Window Door Glass Channel, pair	\$ 60.00
Accelerator Linkage through Firewall Seal	\$ 5.00
H. 1964 AC Hoses Through Firewall Grommet	\$ 5.00
1965-1966 AC Hoses through Firewall Grommet	\$ 11.95
J. 1966 Front Bumper Guard Pads, each	\$ 15.00
Convertible Top Arm Pads, pair	\$ 80.00
K. Convertible Package Tray Link Seals, pair	\$ 10.00
L. Convertible Header Seal, Outer, Black or White	\$ 43.00
1964-1965 Hood Pad Set, 3 piece set	\$ 45.00
Late 1965 Hood Pad Set, 5 piece set	\$ 45.00
1966 Hood Pad Set, 5 piece set	\$ 45.00
M. Roof Rail Weatherstrip, Convertible, 7 piece set	\$ 225.00
Roof Rail Weatherstrip, Hardtop, pair	\$ 80.00
1966 Roof Rail Weatherstrip, Landau, pair	\$ 89.00
Trunk Weatherstrip, Hardtop	\$ 22.00
N. 1964-1965 Trunk Weatherstrip Kit, Convertible	\$ 270.00
1965-1966 Trunk Weatherstrip Kit, Convertible	\$ 270.00
P. Trunk Rear Edge Weatherstrip, Convertible	\$ 130.00
R. Trunk Seal, Hardtop, Black, White, or Gray	\$ 20.00
Trunk Seal with Clips, Hardtop	\$ 29.00
Rocker Drain Seals, each	\$ 2.00
Skirt Seals, pair	\$ 14.00
Front Cowl Drain Tubes, pair	\$ 33.00
S. Rear Cowl Drain Tubes, pair	\$ 65.00
Hood to Cowl Seal	\$ 10.00
T. Hood to Radiator Support Seal	\$ 6.50
U. Hood to Radiator Support Seal Clips, each	\$ .50
Hood Wedge Bumpers, Set of 4	\$ 12.00
Hood Bumper at Radiator Support	\$ 10.00
V. Windshield Pillar Post Weatherstrip, Conv., pair	\$ 45.00
Belt Line Weatherstrip, HT and Convertible	\$ 125.00
Belt Line Weatherstrip, Landau and Town HT	\$ 80.00
Outside Door Handle Gaskets, 4 piece set	\$ 10.00
Parking Light Gaskets 1964-1965, each	\$ 3.50
Parking Light Gaskets 1966, each	\$ 3.50
Rear Bumper To Body Seals (Stone Guards), pr.	\$ 16.00
Fuel Filler Neck To Body Seal	\$ 5.00
Sunvisor Tips, each	\$ 5.00
1964 Steering Column to Firewall Boot	\$ 30.00
Heater Core Firewall Tube Seal, w/o AC	\$ 3.00

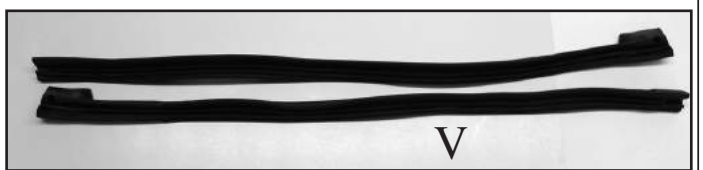
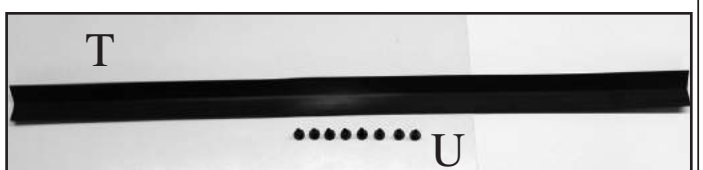
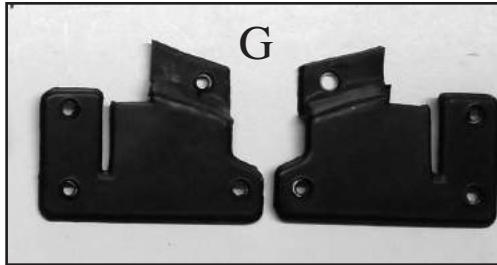
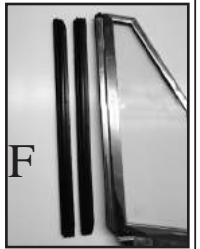
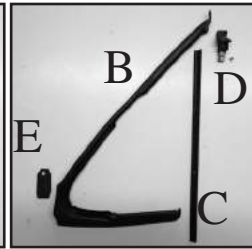

For monthly specials, please visit our website: [www.wilsonsbird.com](http://www.wilsonsbird.com)

# New Body Parts

## New Body Parts 1958 - 1960

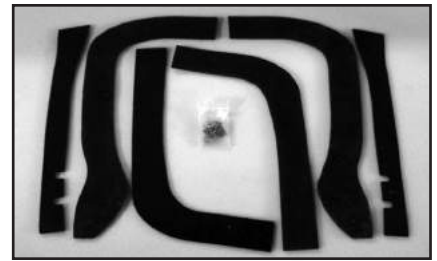
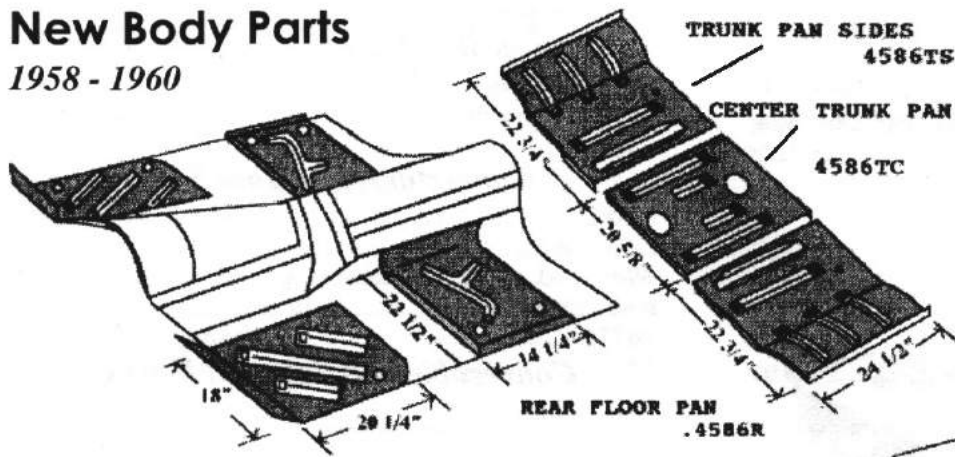

1958-1960 Splash Shield Seals



1958-1960 Splash Shield

FRONT FLOOR PAN  
4586



LOWER REAR FRT. FENDER  
6586



OUTER ROCKER  
2586

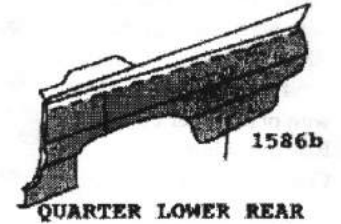

QUARTER LOWER REAR  
1586b



QUARTER DOG LEG  
1586a

**We have a large selection of used body parts, fenders, hoods, trunk lids, doors, trunk floors, quarters, floor sections, rockers, and more.**

**Call for price and availability.**

## New Lower Prices!

### 1964-1966

1958-1960		
Quarter Dog Leg	1586A	\$118.00
Rear Quarter	1586B	\$170.00
Quarter Panel Extension, new		\$ 95.00
Quarter Panel Extension, used		\$ 50.00
Outer Rocker	2586	\$105.00
Front Fender Bottom	6586	\$135.00
Front Floor Pan	4586	\$ 95.00
Rear Floor Pan	4586R	\$ 95.00
Trunk Center	4586TC	\$156.00
Trunk Side	4586TS	\$184.00
Front Wheelwell Rear Splash Shield, L or R		\$ 99.95
Front Wheelwell Splash Shield Seals, set		\$ 49.95

1961-1963		
Quarter Repair	1613	\$320.00
Quarter Dog Leg	1613B	\$115.00
Wheelhouse Extension	3613	\$115.00
Wheelhouse Lower Front	3613B	\$ 70.00
Outer Rocker	2613	\$110.00
Front Floor Pan	4613	\$ 95.00
Rear Floor Pan		\$ 95.00
Front Fender Bottom	6613	\$105.00
Battery Apron Repair	6613B	\$130.00
Side Trunk Repair	TSM3	\$225.00
Rear Deck Panel		\$195.00
Front Wheelwell Splash Shield Seals, set		\$ 49.95

Quarter Full Repair	1646	\$399.00
Quarter Half Repair	1646A	\$340.00
Quarter Dog Leg	1646B	\$115.00
Quarter Bottom Rear	1646C	\$175.00
Wheelhouse Extension	3646	\$125.00
Wheel Top Cap	3646A	\$ 95.00
Outer Rocker	2646	\$110.00
Door Skin Bottom	5646	\$ 85.00
Front Floor Pan	4646	\$125.00
Rear Floor Pan	4646B	\$125.00
Front Fender Bottom	6646	\$ 90.00
Battery Apron Repair	6646B	\$130.00
Trunk Pan Center	6646TC	\$360.00
Trunk Pan Side	6646TS	\$150.00
Trunk Pan End	6646TE	\$100.00
Trunk and Floor Pan Drain Hole Plug, each		\$ 5.00
Front Wheelwell Splash Shield Seals, set		\$ 49.95

### Economy Panels

1964-1966 Trunk Pan Centers, Like Original, 18G. Steel	\$225.00
1964-1966 Front Floor Pan, Left or Right, Like Original, 18G. Steel	\$ 75.00
1964-1966 Rear Floor Pan, Left or Right, Like Original, 18G. Steel	\$ 75.00



# New Body Parts

## New Body Parts 1961 - 1963

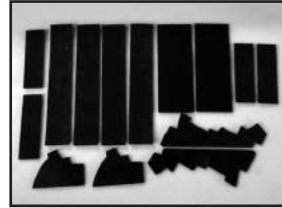

1961-1963 Splash Shield Seals

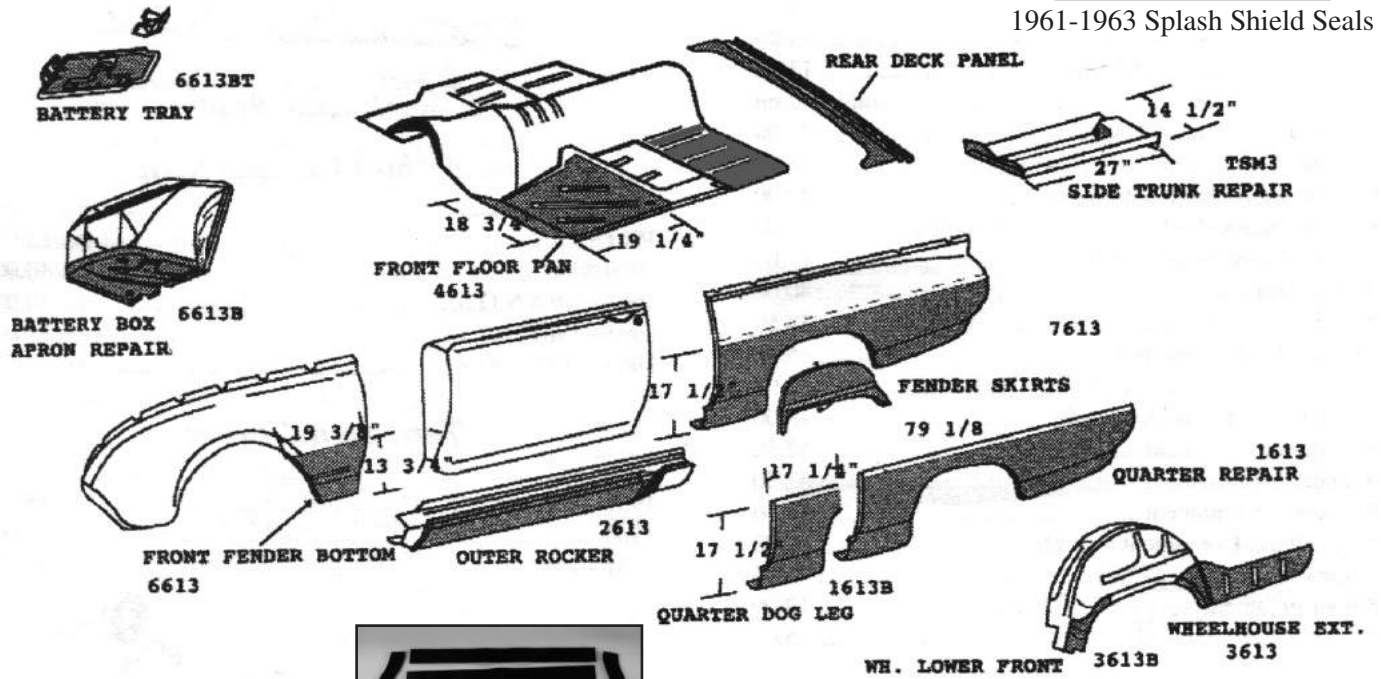

## New Body Parts 1964 - 1966

1964-1966 Splash Shield Seals

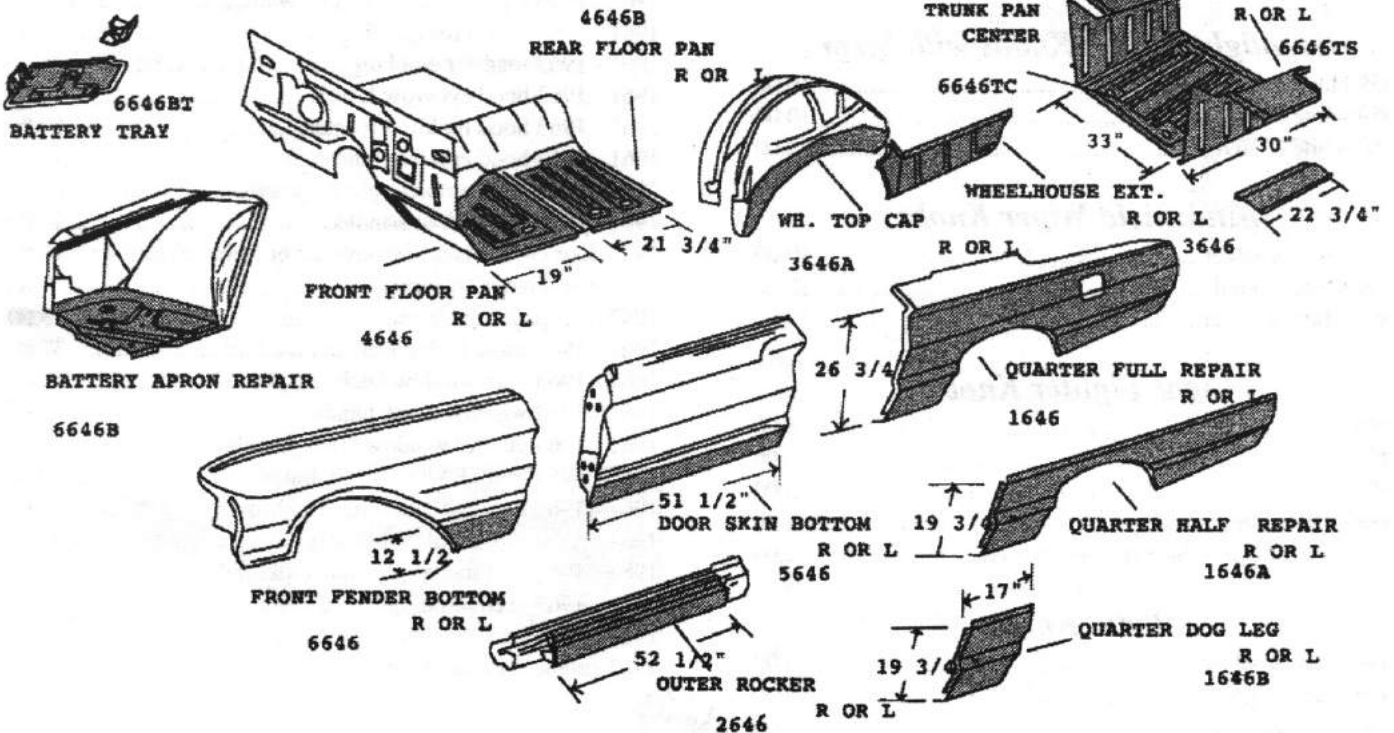



# Fasteners and Small Hardware

- 1964-1966 Spare Tire Hold Down "J" Bolt \$ 6.00
- A. 1962-1964 KH Wire Wheel Hold Down Adapter \$ 5.00
- 1964-1966 Spare Tire Hold Down Wing Nut \$ 3.00
- 1958-1963 Spare Tire Hold Down Bolt \$14.95
- B. 1958-1965 Bumper Bolts \$ 2.50
- C. 1958-1966 Convrt. Top Weather Strip "T" Bolts \$ 1.50
- 1958-1966 Skirt Seal Staples \$ 2.00
- 1958-1966 Plug Wire Holder, Floating \$ 2.50
- 1958-1966 Plug Wire Holder, clip on Valve Cover \$ 3.50
- D. 1958-1966 Wire Loom Straps \$ .65
- E. 1961-1963 Peak Molding Clip \$ 3.00
- F. 1961-1963 Peak Molding Anti-Rattle Clip \$ 1.50
- G. 1961-1963 Peak Molding End Clip w/ Stud \$ 3.50
- H. 1958-1966 Skirt Pins with Nuts \$ 2.00
- J. 1958-1960 Door Panel and Seat Back Clips \$ .50
- K. 1958-1966 Door Handle and Window Clips \$ .50
- 1958-1966 Window Handle Clip Tool \$ 6.95
- 1964-1966 Door Hinge Pin \$ 2.00
- 1964-1966 Door Hinge Pin Bushing \$ 1.50
- 1958-1966 Oil Drain Plug \$ 2.00
- 1958-1966 Oil Drain Plug Washer \$ .50
- 1961-1966 Window Track Roller \$ 1.50
- 1958-1960 Window Track Roller \$ 2.25
- L. 1964-1966 Upper Windshield Molding Clip \$ .50
- 1965-1966 Disc Brake Caliper Hose Banjo Bolt \$ 9.00
- 1965-1966 Outside Mirror Set Screw \$ 1.00
- M. 1958-1966 Emblem Barrel Clip, 3/32" \$ .40
- N. 1958-1966 Emblem Barrel Clip, 1/8" \$ .50
- P. 1958-1966 Emblem Barrel Clip, 3/16" \$ .50
- R. 1964-1966 Upper Door Bumper \$ 2.50
- S. 1964-1966 Lower Door Bumper \$ 2.50
- 1958-1960 Gas Door Bumper \$ 2.50
- 1958-1966 Distributor Vacuum Line Fitting \$ 2.50
- T. 1958-1963 Front Arm Rest Screws \$ .50
- U. 1964-1966 Rear Arm Rest Screws \$ .50
- V. 1958-1966 Shoulder Nut, 3/8"-16 \$ .50
- W. 1958-1966 Shoulder Nut, 5/16"-18 \$ .50
- X. 1958-1966 Shoulder Nut, 1/4"-20 \$ .50
- 1958-1966 Exhaust Manifold Studs, short, each \$ 3.50
- 1958-1966 Exhaust Manifold Studs, long, each \$ 4.50
- Y. 1958-1964 Shoulder Bolt, Fine Thread, Short \$ 1.50
- Z. 1958-1964 Shoulder Bolt, Fine Thread, Long \$ 1.00
- a. 1965-1966 Fender Bolts, Captive Washer \$ .75
- b. 1958-1966 Underhood Cage Nut, Coarse Thread \$ 1.00
- c. 1958-1966 U-Nut, Coarse Thread, Short \$ .50
- d. 1958-1966 U-Nut, Coarse Thread, Long \$ .60
- e. 1961-1963 Rear Deck Panel Bolt \$ 6.00
- f. 1961-1966 Interior Molding Clip \$ 1.00
- g. 1958-1966 Seat Studs w/ Nuts, each \$ 3.50

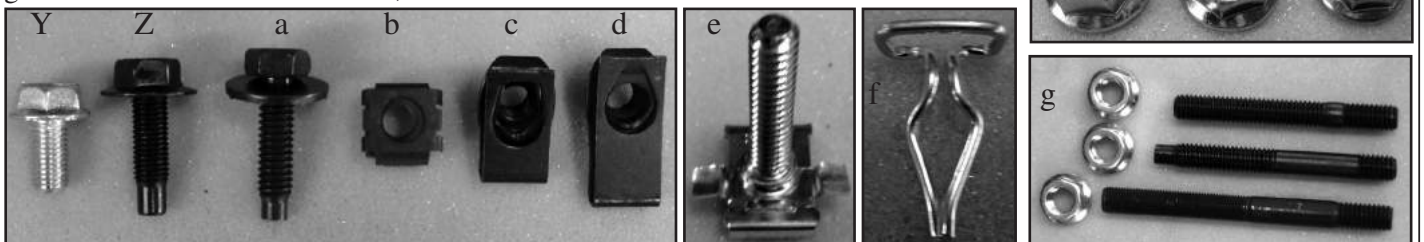
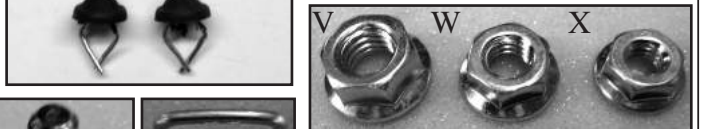
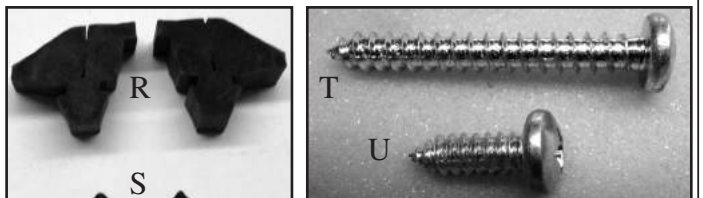
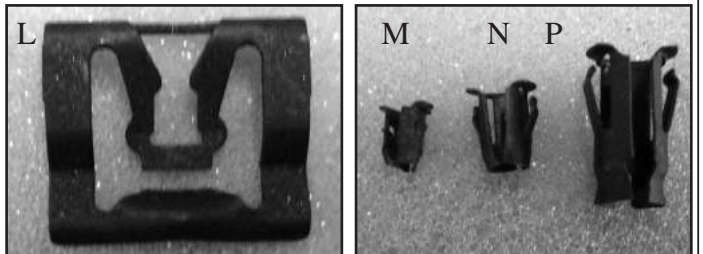
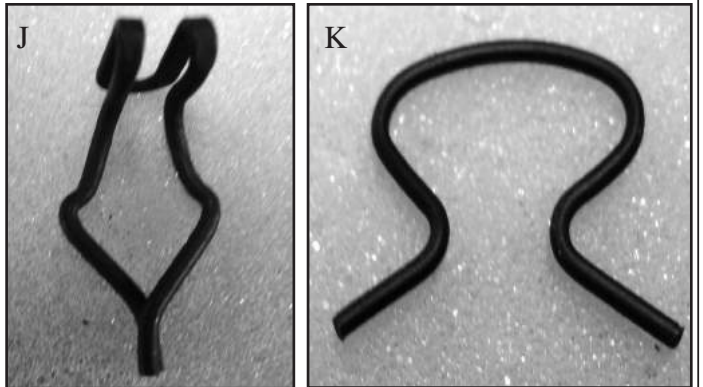
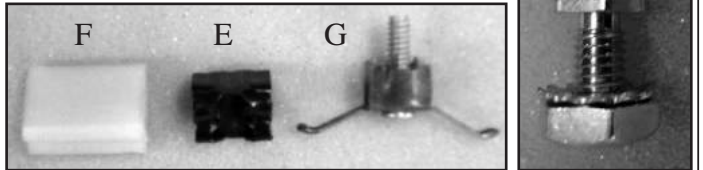
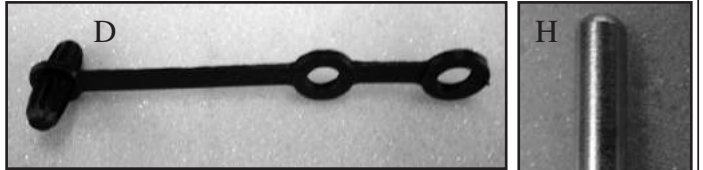
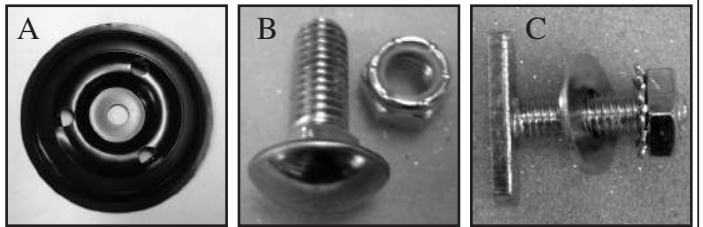

# Fasteners and Small Hardware

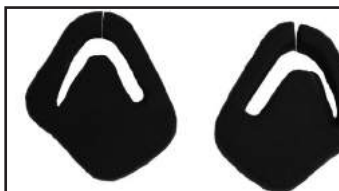
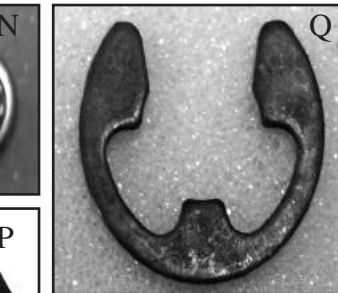
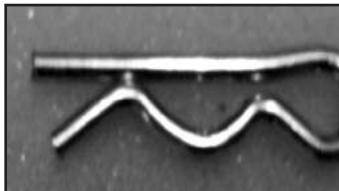
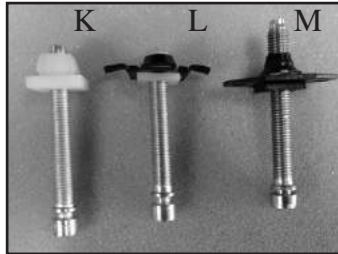
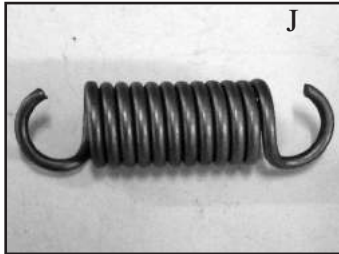
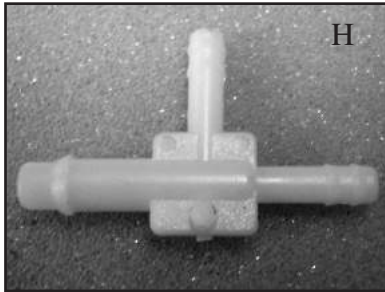
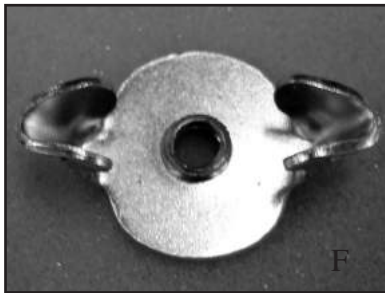
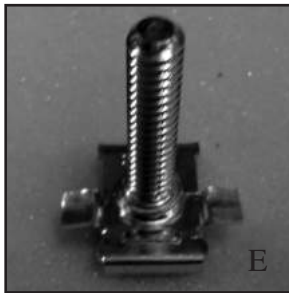
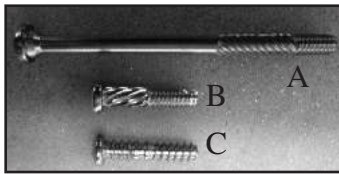

A. 1958-1959 Tail Light Lens Screw	\$ 1.95
1961-1962 Tail Light Lens Screw	\$ 1.25
B. 1964-1965 Tail Light Lens Screw	\$ 1.25
C. 1965-1966 Tail Light Lens Screw	\$ 1.25
1964-1965 Tail Light Lens and Trim Screw Kit	\$19.95
1966 Tail Light Lens and Trim Screw Kit	\$34.95
1958-1966 Parking Light Lens Screw	\$ 1.25
1961-1963 Gas Door Bumper	\$ 1.75
1964-1966 Gas Door Bumper	\$ 2.00
1958-1966 Exhaust Manifold Lock Clips, 16 pc	\$16.50
1958-1966 Exhaust Man. Bolt & Lock Kit, 32pc	\$26.00
D. 1964-1966 Floor Pan and Trunk Floor Steel Plug	\$ 5.00
E. 1961-1966 Splash Shield Mounting Stud	\$ 4.95
F. 1958-1966 Air Cleaner Wing Nut	\$ 2.00
G. 1958-1966 Lug Nuts, each	\$ .50
1958-1966 Wheel Studs	\$ 3.25
1965-1966 Caliper Bleeder Screw	\$ 3.25
1958-1960 Hood Release Handle	\$17.00
1958-1960 Windlace Clip	\$ 3.95
1958-1963 Inside Door Handle Tension Spring	\$ 1.50
1958-1966 Door Jam Switch	\$ 8.50
1958-1966 Sill Plate Screw Kit	\$ 2.50
1964-1966 Door Weatherstrip Clip Retainer	\$ .25
H. 1958-1966 Washer Tube Tee Fitting	\$ 1.50
1964-1966 Hood to Radiator Seal Clip	\$ .30
1958-1960 Heater Hose Spring Clamp	\$ .50
1958-1966 Trans. Cooling Line Hose Clamp	\$ 1.00
1958-1966 Fuel Line Crimp Clamp	\$ 1.00
1964-1966 P/S Return Line Hose Clamp	\$ 1.00
1961-1966 Accelerator Linkage E-Clip	\$ .30
J. 1964-1965 Headlight Spring	\$ 2.00
K. 1961-1963 Headlight Adjuster Screw Kit	\$ 3.00
L. 1964-1965 Headlight Adjuster Screw Kit	\$ 6.95
M. 1966 Headlight Adjuster Screw Kit	\$ 2.50
N. 1958-1966 Convertible Top Pin Clip	\$ 1.00
P. 1958-1960 Conv. Trunk Hinge Bumpers, pair	\$ 7.00
Q. 1958-1964 Brake Booster Rod Clip	\$ 3.50
R. 1958-1966 Emblem Speed Nut, 1/8"	\$ .25
S. 1958-1966 Emblem Speed Nut, 3/16"	\$ .30
T. 1958-1966 Emblem Speed Nut, 1/4"	\$ .30
U. 1958-1966 Window Switch Clip	\$ 2.95
V. 1958-1963 Window Switch Clip	\$ 2.95
W. 1964-1966 Window Switch Clip	\$ 2.95
X. 1961-1966 Side Body Molding Clip	\$ 3.25
Y. 1958-1960 Carburetor Rod End Clip	\$ 3.00
Z. 1958-1960 AC Box Clip	\$ 2.50
a. 1964-1966 Rear Seat Upper Moulding Clip	\$ 1.50

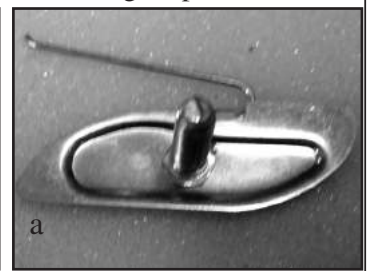
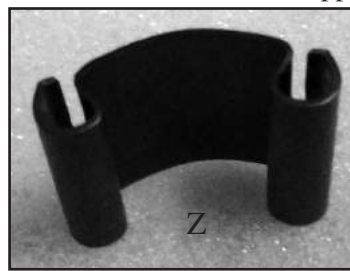



# Radios and Radio Parts

## USA-230 AM/FM Stereo

- Features:** \$179.00
- AM/FM Stereo, 200 Watt Total Output
  - Electronic Tuner
  - Electronic Bass and Treble Controls
  - Digital Clock
  - 4 Way Balance / Fader
  - Pre-Set Scan
  - 16 Presets (12 FM/4 AM)
  - 4-Channel RCA Pre-outs
  - Chrome Face
  - RCA Inputs, with RCA to 1/8" adapter included
  - Power Antenna Lead



## USA-630 AM/FM Stereo

- Features:** \$239.00
- AM/FM Stereo 16 Presets (12 FM, 4 AM)
  - RDS Tuner
  - 300 Watts Total Output
  - USB Port
  - Ipod Dock included
  - Electronic Tuning and Volume Control
  - 2-Channel Auxiliary input
  - Digital Clock
  - Digital EQ
  - Alphanumeric Display
  - USA/Euro Tuning

## Radios, Used and Tested

- |                          |          |
|--------------------------|----------|
| 1958 AM only             | CALL     |
| 1959-1960 AM only        | \$150.00 |
| 1961-1963 AM only        | \$150.00 |
| 1963 AM/FM Original      | CALL     |
| 1964-1966 AM only        | \$150.00 |
| 1964 AM/FM Original      | CALL     |
| 1965-1966 AM/FM Original | CALL     |
| 1966 AM Stereo 8-Track   | CALL     |

## Antennas

- |  |          |
|--|----------|
| H. 1958-1960 Front Mount Antenna Assembly        | \$ 70.00 |
| 1957-1960 Trunk Mount Antenna Assembly           | \$100.00 |
| J. 1961-1963 Antenna Assembly                    | \$ 65.00 |
| K. 1964-1966 Antenna Assembly                    | \$ 65.00 |
| L. 1961-1966 Antenna Mast Only                   | \$ 25.00 |
| 1964-1966 Power Antenna Assembly, Used           | CALL     |
| 1964-1966 Power Antenna Nipple,<br>Black Plastic | \$ 15.00 |

## AM/FM Conversion Stereos

- An original AM radio converted to an AM/FM radio without changing the appearance.
  - 180 Watts Total Output
  - 4 Channel Stereo
  - RCA-style inputs for iPod, Satellite Radio, etc.
  - 1958-1960
  - 1961-1963
  - 1964-1966
  - There is a \$100.00 core charge on all conversions.
  - Also available for other models, please call for info.
- |  |          |
|--|----------|
| AM/FM Stereo Conversion  | \$450.00 |
| Ipod Adapter Cable: Plays and Charges Ipod<br>(except with lightning plug) | \$ 50.00 |

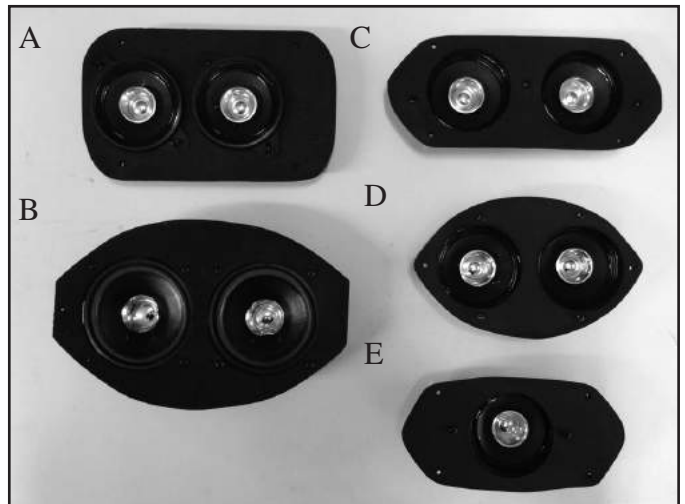

## Speakers

- |  |          |
|--|----------|
| A. 1958-1960 Console, Dual Speaker, new  | \$ 34.00 |
| B. 1961-1963 Dash, Dual Speaker, new   | \$ 34.00 |
| C. 1964-1966 Dash, Dual Speaker, new   | \$ 34.00 |
| D. 1964-1966 Rear, Dual Speaker, new   | \$ 34.00 |
| <b>Above speakers are only \$29.00 when purchased as a kit with any of our radios!</b> |          |
| E. 1966 Door Speaker, new, each  | \$ 16.00 |
| F. 1964-1966 Dash OEM Speaker, 4"x10"  | \$ 19.95 |
| G. 1964-1966 Rear OEM Speaker, 5"x7" <b>NEW</b>  | \$ 19.95 |





# Accessories



## Paints

1955-1957 Engine Ford Red	\$ 7.00
A. 1958-1959 Engine Light Blue	\$ 7.00
B. 1960 Valve Cover Gloss Yellow	\$ 7.00
1965 Valve Cover Gold	\$ 7.00
C. 1966 Engine Ford Blue	\$ 7.00
D. Cast Blast	\$ 7.50
E. Alumi Blast	\$ 7.50
F. Stainless Steel	\$ 9.00
G. High Temperature Cast Blast	\$ 9.00
H. High Coverage Red Oxide Primer, 20 oz. Can	\$ 9.00
J. Spray Adhesive (for Hood Pads)	\$10.00
K. High Gloss Frame Black	\$12.00



We offer a wide range of services, including:

- Expert Convertible Top Repair
  - Expert Electrical Repair
  - Exhaust Installation
- Window Motor Installation
  - Front End Service
  - Brake Service
  - Interior Installation

## License Plate Brackets

L. 1958-1960 Front Bracket, new	\$21.00
M. 1961-1963 Front Bracket, new	\$20.00
N. 1964-1965 Front Bracket, new	\$27.00
P. 1966 Front Bracket, new	\$19.00
Q. 1958-1966 License Plate Screws, pair	\$ 1.00
R. 1958-1966 License Plate Screw Receivers, pair	\$ 1.50
S. 1958-1966 License Plate Bumpers, each	\$ 1.75

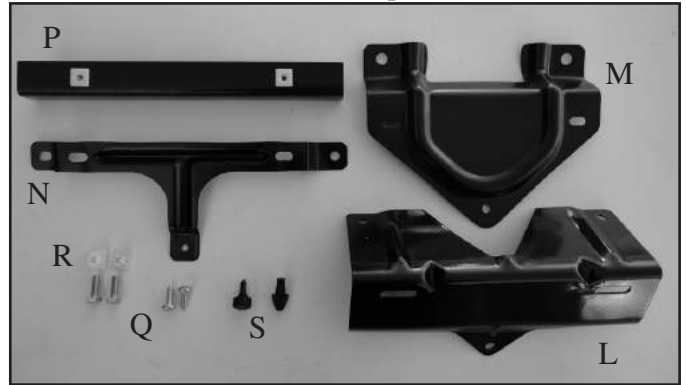

## Thunderbird Specialty Parts

Thunderbird Fender Cover	\$28.00
--------------------------	---------



## Interior Vinyl Dyes

Interior Vinyl Dye, per can	\$19.95
Vinyl Surface Prep and Cleaner, per can	\$19.95
Interior Vinyl Clear Coat, per can	\$19.95



These dyes are specially matched to all original interior colors. These dyes are specially formulated to resist cracking or chipping. They can be used on all vinyl surfaces for that factory fresh look! Please have trim code available when ordering.

For monthly specials, please visit our website: [www.wilsonbird.com](http://www.wilsonbird.com)